

# Wear Resistant Parts

# 2024

- Agricultural
- Vegetation Management
- Grass Care

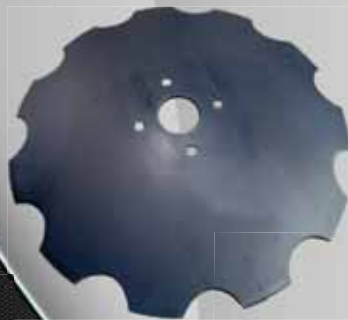

Ph: 07 3881 3464

[sales@asproducts.com.au](mailto:sales@asproducts.com.au)

[www.asproducts.com.au](http://www.asproducts.com.au)

**SIMPLE TO ORDER**  
PHONE 07 3881 3464  
EMAIL [sales@asproducts.com.au](mailto:sales@asproducts.com.au)

Feel free to discuss your requirements with our sales team on the above numbers or via email  
[sales@asproducts.com.au](mailto:sales@asproducts.com.au)



### **PAYMENT OPTIONS:**

We provide most payment options including:  
Mastercard, Visa, EFT, cheque & 30 day trading accounts for approved repeat customers.

### **NATIONAL DISTRIBUTION**

Rapid dispatch & competitive freight rates Australia wide. Ask us for the best freight options for your requirements.



**SERVICE YOU CAN COUNT ON NO MATTER WHERE YOU ARE IN AUSTRALIA!**  
Fast, efficient dispatch. Experienced, friendly and service oriented sales team.

---

### **ASP ACCOUNT HOLDERS - WEBSITE ORDERS**

Please email [accounts@asproducts.com.au](mailto:accounts@asproducts.com.au) or call **07 3881 3464** to request your secure website account login details. Place orders, check current pricing & stock, review previous orders etc.

**[www.asproducts.com.au](http://www.asproducts.com.au)**

---

ASP has the sole Australian distributorship rights for two of Europe's leading specialist wear resistant parts manufacturers.

Our suppliers utilize world class manufacturing techniques and source the finest raw materials to ensure you get maximum wear life and value for money!



**LA PIÑA**  
**WORK WELL DONE**





## **CONTENTS**

<b>Ripper Points, Tines, Shanks, Clamps etc</b>	<b>Pages 4 - 9</b>
<b>Rotary Hoe &amp; Power Harrow Blades</b>	<b>Pages 9 - 14</b>
<b>Speed Tiller Discs</b>	<b>Pages 14</b>
<b>Discs &amp; Coulters</b>	<b>Pages 14 - 17</b>
<b>Slasher Blades</b>	<b>Pages 18 - 31</b>
<b>Mulcher Flails &amp; Hammers</b>	<b>Pages 32 - 46</b>
<b>Stump Grinder &amp; Fixed Mulcher Teeth</b>	<b>Page 47</b>
<b>Push Mower &amp; Finishing Mower Blades</b>	<b>Pages 48 - 51</b>
<b>Turf Cutter / Harvester Blades</b>	<b>Page 52</b>
<b>Ride On Mower Blades</b>	<b>Pages 53 - 80</b>
<b>Edger Blades</b>	<b>Page 81</b>
<b>Trimmer Line &amp; Trimmer Heads</b>	<b>Pages 82 - 87</b>
<b>Litter Pickup Tools</b>	<b>Page 84</b>

**QUALITY PARTS, AFFORDABLE PRICES!**

# Ripper Points & Sweeps

## Reversible Point - Coil Tine

- AS-01317 40mm x 12mm x 300mm (31SL-1)
- AS-01319 50mm x 16mm x 310mm (31SL-3)
- AS-01320 65mm x 16mm x 310mm (31SL-4)

7/16 Bolt holes at 51mm centres  
ASP-09024 Bolt & Nut



## Reversible Point - Suit Rear Mount Coil Tines

- AS-800006 40mm x 16mm x 270mm

14mm Bolt holes at 45mm centres  
ASP-09023 Bolt & Nut



## Reversible Point

- AS-01329 65mm x 13mm x 380mm

1/2" Bolt holes at 57mm centres  
ASP-09023 Bolt & Nut



## Universal Ripper Point

- AS-01349 62.5mm x 20mm x 300mm
- 4 x 1/2" Bolt holes / slots to suit between 51mm to 112mm centres - ASP-09023 Bolt & Nut

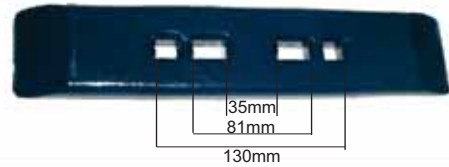

## Feed Down Point

- AS-01335 Short style (314H) 43cm long
- AS-01336 Long style (315H) 58cm long

2" wide x 1/2" thick Point to suit Yeoman, Napier etc

AS-09247 Clamp & Screw



## North American Chisel Plough Point -

- AS-01322 55mm x 15mm x 400mm
- 13.5mm Bolt holes at 45 - 65mm centres  
ASP-09023 Bolt & Nut



## Sweeps - suit Coil Tines

- AS-5305H 5 Inch x 6mm
- AS-5306H 6 Inch x 6mm
- AS-5308H 8 Inch x 6mm
- AS-53010H 10 Inch x 6mm
- AS-53012H 12 Inch x 6mm

**TUNGSTEN HARD FACED SWEEPS**  
Use ASP-09024 Bolt & Nut



## Scarifier & Harvester Point

- AS-05230 180mm x 45mm wide
  - AS-05230H **HARD FACED**
- Knock on cast point  
OEM Ref 6Y5230 & 2D5572



## Alabama Sweeps

- ASP-58118-8 18"
- ASP-58120-8 20"
- ASP-58122-8 22"
- ASP-58124-8 24"

Spanish BORON 8mm Thick Sweeps, 2 x 1/2" Bolt Holes @ 56mm centres suit Friction Trip etc Use ASP-09370 Bolt & Nut



## 3 x 1" Shanks & Friction Trips

- AR-01537 shank 75 x 25 x 785mm
- Bull nose leading edge for better trash flow. Heat Treated. Suits Friction Trip assemblies.



- AR-01539 Friction Trip
- AR-06370 Hardware kit

# Coil Tines & S Tines

## Coil Tine - Vertical

AR-01488 25mm Sq Left Hand  
AR-01489 25mm Sq Right Hand

AR-01476 32mm Sq Left Hand  
AR-01477 32mm Sq Right Hand

Use AS-01317 / 19 / 20 Points or AS-53 Sweeps

'A' Dimension:  
25mm Tines are 780mm  
32mm Tines are 930mm



LEFT HAND

## Coil Tine - Front

AR-01480 25mm Sq Left Hand  
AR-01481 25mm Sq Right Hand

AR-01468 32mm Sq Left Hand  
AR-01469 32mm Sq Right Hand

Use AS-01317 / 19 / 20 Points or AS-53 Sweeps

'A' Dimension:  
25mm Tines are 580mm  
32mm Tines are 680mm

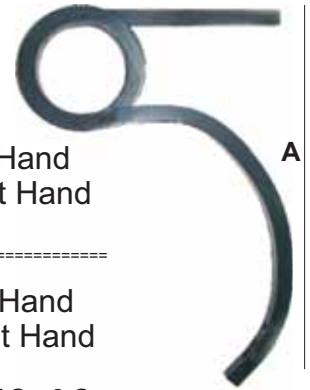

## Coil Tine - Rear 25mm

AR-Q25SVVDX L/Hand  
AR-Q25SVVSX R/Hand

Use only AS-800006  
Reversible Point  
270mm x 40mm x 16mm  
(Use ASP-09023 Bolt)  
Not suitable for  
ASP Sweeps

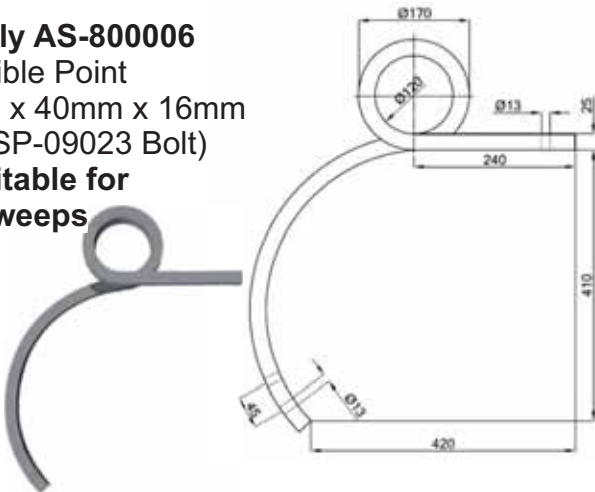

## Coil Tine - Rear 30mm

AR-Q30SVVDX L/Hand  
AR-Q30SVVSX R/Hand

Use only AS-800006  
Reversible Point  
270mm x 40mm x 16mm  
(Use ASP-09023 Bolt)  
Not suitable for  
ASP Sweeps

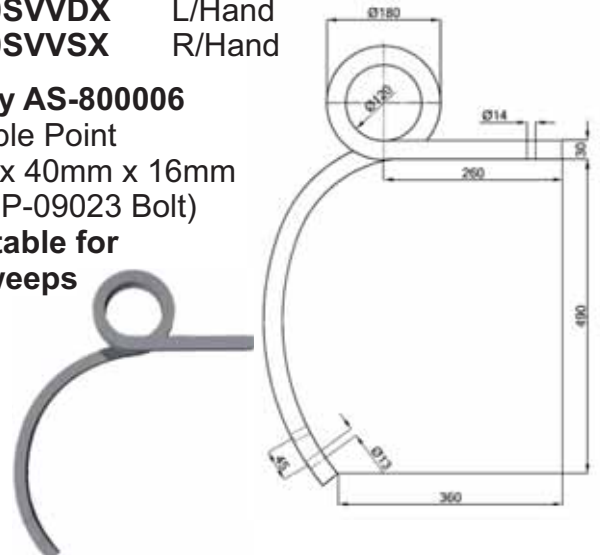

## H/Duty S Tine - 70mm x 12mm

AR-F70SVV S Tine  
AR-AF7012/60 Clamp 60mm Bar  
AR-AF7012/65 Clamp 65mm Bar

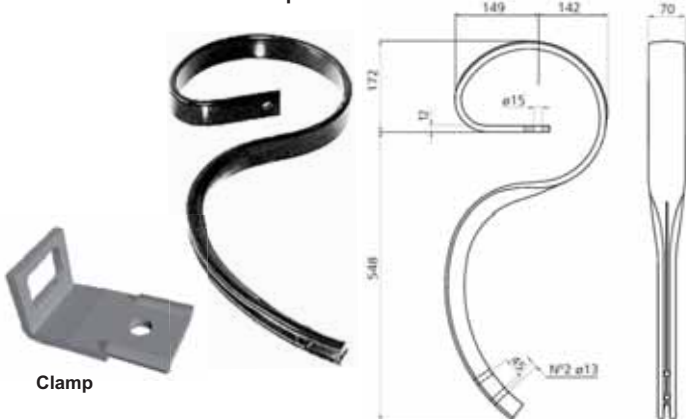

## Points to suit 70mm x 12mm S Tine

AR-550299 Reversible Point  
AR-550301 180mm Sweep  
AR-550308 Bolt & Nut M10x55

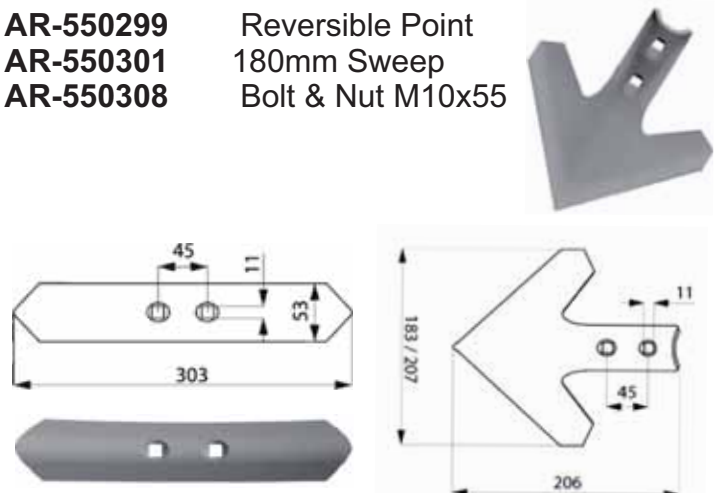

# S Tines, Tines & Shanks

## S Tine

45mm x 12mm

AR-F45SVV S Tine

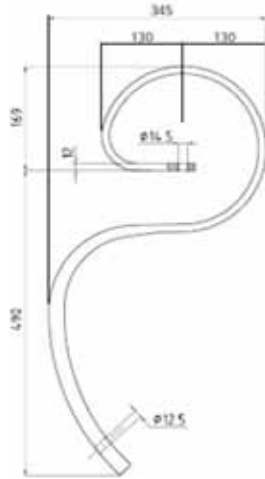

## Points & Sweeps to suit 45mm x 12mm S Tines

- AR-550027 4" Sweep
- AR-550028 6" Sweep
- AR-550067 Reversible Point 255 x 55 x 6mm
- AR-550034 Reversible Point 40 x 6mm
- AR-550102 Reversible Point 40 x 8mm
- AR-AF4512/50 Clamp 50mm Bar
- AR-AF4512/65 Clamp 65mm Bar
- AR-VF4512 Bolt & Nut



## S Tine

32mm x 12mm

AR-F12SVV S Tine

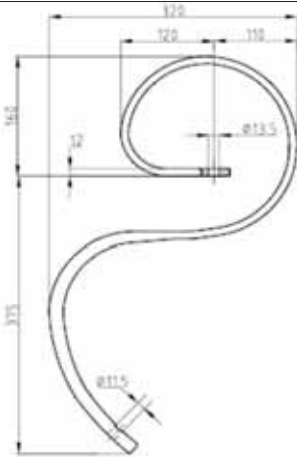

## Points & Sweeps to suit 32mm x 12mm S Tines

- AR-550027 4" Sweep
- AR-550028 6" Sweep
- AR-550034 Reversible Point 40 x 6mm
- AR-550102 Reversible Point 40 x 8mm
- AR-AF3212/16 Clamp 50mm x 16mm Bar
- AR-AF3212/50 Clamp 50mm x 50mm Bar
- AR-VF4512 Bolt & Nut M10 x 45mm



## Rigid Tine

AR-01107 32mm Square x 785mm

2 x 7/16" Bolt holes at 46 to 53mm centres

Use AS-01317, AS-01319 or AS-01320 Points & AS-53.. Sweeps



## Cultivator Shank

AR-01512  
50mm x 25mm  
x 530mm

Use AS-01329 Point

Suits Yeoman, Berends,  
Waratah &  
Jarrett style cultivators.

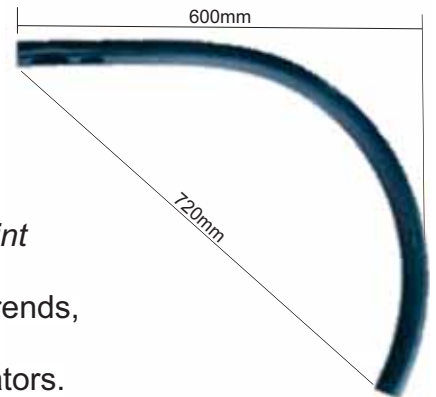

## Cast Aerator "Shattertine"

- CI-08862 Left Hand
- CI-08863 Right Hand
- CI-08862H **HARD FACED**
- CI-08863H **HARD FACED**
- CIA-09362 Bolt & Nut

(13.5mm holes @ 46mm centres,  
9" long from centre of top hole)  
Same design as the AerWay Shattertine.  
To fit Berends, Agrifarm, Agrivator & Leda etc



## Beet Knife Tine

AR-01536 32mm Square  
Beet Knife Tine, 32mm square x 740mm long with  
3 x 3/8" holes at 32mm - 57mm centres



# Weeder Rake & Cultivator Tines

## Multi Weeder Rake Tine 16mm

**AR-01383** Left Hand  
**AR-01384** Right Hand

692mm Height,  
 325mm length,  
 14.3mm Eye



## Multi Weeder Rake Tine 19mm

**AR-01385** Left Hand  
**AR-01386** Right Hand

692mm Height,  
 325mm length,  
 14.3mm Eye

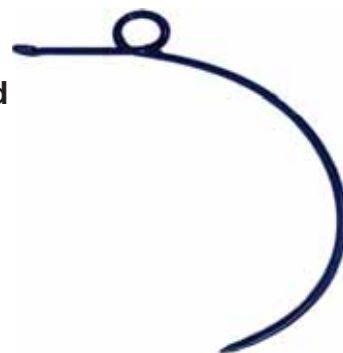

## Multi Weeder Tracking Rake

**AR-01449** Right Hand  
**AR-06919** Left Hand

**Vertical Eye**  
 16mm Tine  
 14.5mm Hole  
 670mm Height



## Tracking Rake Tine

**AR-01448** Tine 16mm,

692mm Height  
 365mm Length



## Cultivator Rake Tine 19mm with 25mm ID Ferrule

**AR-01396** Height 686mm,  
 Length 816mm

**AR-01400** Height 686mm,  
 Length 435mm

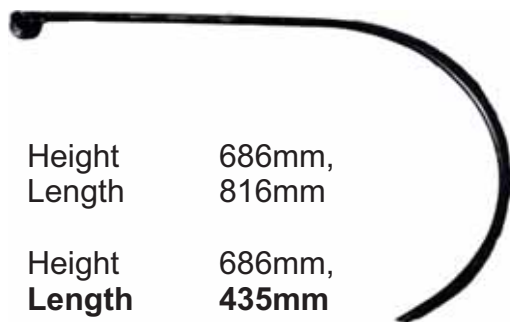

## Baselier Bed Former Blade

**AR-09213** 335mm long x 40mm x 10mm thick

## Baselier Inter-Row Blade

**AR-09216** 230mm long x 40mm x 10mm thick

Approx 90mm long **TUNGSTEN WELD**  
 2 x 12mm holes at 80mm centres



## Struik Inter-Row Blade

**AR-09217** 210mm long x 40mm x 10mm thick

2 x 12mm holes at 60mm centres  
 Approx 90mm long **TUNGSTEN WELD**



## Crescent Knives

**AR-05459 & AR-05460 LH & RH**

11mm Hole & 11mm X 34mm Slot Hole  
 @ 42mm centres.  
 Length A = 290mm,  
 Length B = 150mm  
 50mm Wide x 10mm Thick



# Ripper Legs, Points & U Bolts

## Ripper Point suit Yeoman

**TUNGSTEN HARD FACED - With Tile**

ACAG-08742 Standard Hard Faced with tile



## Ripper Point suit Yeoman

**H/DUTY TUNGSTEN HARD FACED**

ACAG-08742H H/Duty Hard Faced  
(With extra Rib at back of point)



## ASP Ripper Point

ACAG-003 Point



(Will also suit #8 Agrowplow Shanks)

## ASP Ripper Point

**TUNGSTEN HARD FACED**

ACAG-003HF



## ASP Ripper Legs

- ACAG-024 24" Complete Assembly
- ACAG-031 30" Complete Assembly
- ACAG-001 24" Shank only
- ACAG-030 30" Shank only
- ACAG-SUB Clamp Assembly (Top & Bottom)

1" (25mm) shear pin

Breakout force approximately  
4000ft.lbs for 24" Leg

Approximate power  
requirements per shank:  
7.5-11KW (10-15 HP)

Suits 100mm square RHS  
frames



**NOW WITH** →  
**TUNGSTEN HARD FACING**  
**AS STANDARD ON**  
**THE SHANK LEADING EDGE**  
(Standard Point & Guard supplied  
with Complete Assembly).

## ASP Ripper Leg Parts

- ACAG-015 Shin Guard
- ACAG-015H **HARD FACED** Shin Guard
- ACAG-014 Shear Pin
- ACAG-EN761 Pin Clip



## Gessner Ripper Point, Guard &

### Shear Pin

**TUNGSTEN HARD FACED**

- ACAG-09160H Gessner style Point
- ACAG-09161H Gessner style Shin Guard
- ACAG-014 Shear Pin (refer above for size)
- ACAG-EN761 Pin Clip



## U & V Bolts

- AR-07328 U Bolt 4 x 4 x 3/4"
- AR-315031K U Bolt 7 x 7 x 3/4"
- AR-315032K U Bolt 7 x 7 x 7/8"
- AR-315033K U Bolt 6 x 4 x 3/4"
- AR-315034K U Bolt 6 x 6 x 3/4"
- ASP-101-350 V Bolt 100x100x22mm



ASP U Bolts are grade 8.8 high tensile.  
Supplied complete with nuts and spring washers.



# Clamps & Wedges, Rotary Hoe Blades

## Clamps & Wedges - 2" Toolbar

AR-04279 1" Tine to 2" Toolbar  
AR-04285 Wedge to suit AR-04279

AR-04277 1 1/4" Tine to 2" Toolbar  
AR-04283 Wedge to suit AR-04277

**AR-04278** **Spreader Clamp**  
AR-04283 Wedge to suit AR-04278



## Clamps & Wedges - 2 1/2" Bar

AR-04273 1 1/4" Tine to 2 1/2" Toolbar  
AR-04283 Wedge to suit AR-04273

**AR-04274** **Spreader Clamp**  
AR-04283 Wedge to suit AR-04274



## Clamps & Wedges - 3 1/2" Bar

AR-01496 1 1/4" Tine to 3 1/2" Toolbar  
AR-04346 Wedge to suit AR-01496

**AR-01495** **Spreader Clamp**  
AR-04346 Wedge to suit AR-01495



## Clamps & Wedges - 4" Toolbar

AR-03896 1 1/4" Tine to 4" Toolbar  
AR-04346 Wedge to suit AR-03896

**AR-06964** **Spreader Clamp**  
AR-04346 Wedge to suit AR-06964



## DURA-TUNG RANGE FROM ASP!

THE DURABLE TUNGSTEN RANGE FROM ASP USES AN ULTRA TOUGH TUNGSTEN COATING FOR MAXIMUM WEAR RESISTANCE WHILST STILL MAINTAINING A SHARP CUTTING EDGE! DESIGNED EXCLUSIVELY FOR THE AGRICULTURAL INDUSTRY. AVAILABLE ON A SELECT RANGE OF ASP HOE BLADES.



Thin coating of fine grit TUNGSTEN hard facing along the cutting edge and bottom of the blade enables maximum wear resistance without reducing the cutting ability of the blade.



**eurozappa**

**ASP Hoe Blades are sold in EQUAL QUANTITIES of left hand & right hand. They are shipped in sturdy boxes, generally 20 blades per box.**

ASP Rotary Hoes blades are manufactured in Italy from Boron Steel. OEM numbers are for reference only.

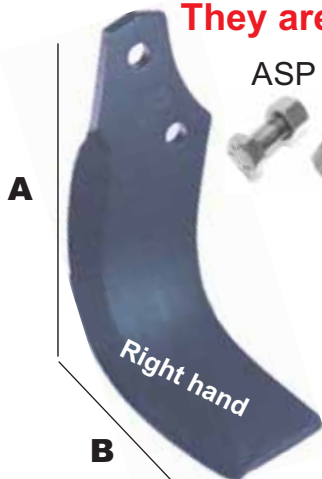

**SPEED BLADE**

ASP Rotary Hoe and Power Harrow blades are the hardest, longest lasting blades sold in Australia. They are super hardened to 50Rc where others often are softer. We can do this because our blades are made from European Boron steel which enables them to be made harder without the risk of them becoming brittle. As well, ASP blades undergo a special heat treatment process that produces different characteristics in the steel where really needed, extra hardness at the blade edge and extra elasticity at the bolt holes.



**POWER BLADE**

# Rotary Hoe Blades

APPLICATION OEM REF TYPE SIZE A SIZE B HOLE CENTRES SECTION BOLT

<b>AGRATOR</b>		RH-08782 -10 & RH-08783 -10 NEW 10mm THICK OPTION RH-08782 - 10T & RH-08783 - 10T NEW HARD FACED 10mm THICK OPTION							
RH-08782 RH-08783	MRP SERIES	MR30856 MR30857	POWER 237004	193mm	140mm	16.5mm	75mm	105x8mm	RHA-08118 M16 X 48mm
<i>*Tungsten Hard Faced Option available</i>									
RH-09146 RH-09147	MRP SERIES		SPEED 225046	210mm	140mm	16.5mm	75mm	105x8mm	RHA-08118 M16 X 48mm
<b>BREVIGLIERI</b>									
RH-08116 RH-08117	B83, 103, 123, 170, 250 DOBLE & MAXI	0064818 D/S	POWER 153016	185mm	135mm	14.5mm	57mm	80x8mm	RHA-08419 M14 X 40mm
<i>*Tungsten Hard Faced Option available</i>									
RH-08924 RH-08925	H/DUTY 10MM		POWER 153064	180mm	135mm	14.5mm	57mm	80x10mm	RHA-08419L M14 X 55mm
<i>*Tungsten Hard Faced Option available</i>									
RH-08243 RH-08244	B83, 103, 123, 170, 250 DOBLE & MAXI	0064811 D/S	SPEED 153015	185mm	135mm	14.5mm	57mm	80x8mm	RHA-08419 M14 X 40mm
<i>*Tungsten Hard Faced Option available</i>									
<b>CELLI</b>									
RH-08386 RH-08387	'A' SERIES	522514 522515	POWER 153011	185mm	135mm	12.5mm	50mm	70X6mm	N/A
RH-08392 RH-08393	ALPHA, C & CE	331526 331527	POWER 153027	185mm	135mm	14.5mm	50mm	70X7mm	RHA-08419 M14 X 40mm
RH-08390 RH-08391	ALPHA, C & CE	331528 331529	SPEED 153028	195mm	135mm	14.5mm	50mm	70X7mm	RHA-08419 M14 X 40mm
RH-08388 RH-08389	AG SERIES	531511 531512	SPEED 153025	164mm	110mm	12.5mm	40mm	60X6mm	N/A
RH-08116 RH-08117	E, HV, H, F, G, K, PIONEER, TIGER & ERGON	722533/34 422512/13 B6225/6	POWER 153016	185mm	135mm	14.5mm	57mm	80X8mm	RHA-08419 M14 X 40mm
<i>*Tungsten Hard Faced Option available</i>									
RH-08924 RH-08925	H/DUTY 10MM	722547 722548	POWER 153064	180mm	135mm	14.5mm	57mm	80X10mm	RHA-08419L M14 X 55mm
<i>*Tungsten Hard Faced Option available</i>									
RH-08243 RH-08244	E, HV, H, F, G, K, PIONEER, TIGER & ERGON	722537/38 422514/15	SPEED 153015	185mm	135mm	14.5mm	57mm	80x8mm	RHA-08419 M14 X 40mm
<i>*Tungsten Hard Faced Option available</i>									
RH-08986 RH-08987	<b>LONG SHANK</b> ALTERNATIVE TO RH-08116 / 7	B6229 / 30	POWER 153055	207mm	135mm	14.5mm	57mm	80x10mm	RHA-08419L M14 X 55mm
<i>*Tungsten Hard Faced Option available</i>									
RH-09177 RH-09178	SUPER TIGER	722560 722561	POWER 153060A	180mm	135mm	16.5mm	57mm	80x10mm	RHA-08118 M16 X 48mm
RH-09223 RH-09224	<b>LONG SHANK</b> SUPER TIGER		POWER 153055A	207mm	135mm	16.5mm	57mm	80X10mm	RHA-08118 M16 X 48mm

# Rotary Hoe Blades

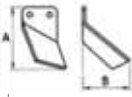
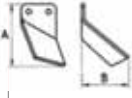
APPLICATION		OEM REF	TYPE	SIZE A	SIZE B	HOLE	CENTRES	SECTION	BOLT
<b>FALC</b>		<b>RH-08782 -10 &amp; RH-08783 -10 NEW 10mm THICK OPTION</b> <b>RH-08782 - 10T &amp; RH-08783 - 10T NEW HARD FACED 10mm THICK OPTION</b>							
RH-08116 RH-08117	C,CS & E	762427 762428 884070/71	POWER 153016	185mm	135mm	14.5mm	57mm	80x8mm	RHA-08419 M14 X 40mm
				*Tungsten Hard Faced Option available					
RH-08924 RH-08925	H/DUTY ALTERNATIVE TO RH-08116 / 7		POWER 153064	180mm	135mm	14.5mm	57mm	80x10mm	RHA-08419L M14 X 55mm
				*Tungsten Hard Faced Option available					
RH-08243 RH-08244	C,CS & E	884000 884001	SPEED 153015	185mm	135mm	14.5mm	57mm	80x8mm	RHA-08419 M14 X 40mm
				*Tungsten Hard Faced Option available					
RH-08782 RH-08783	F, G, GAMMA & KAPPA	762719 /20 25.09.59 / 60	POWER 237004	193mm	135mm	16.5mm	75mm	105x8mm	RHA-08118 M16 X 48mm
				*Tungsten Hard Faced Option available					
RH-09146 RH-09147	F, G, GAMMA & KAPPA	109343 109344	SPEED 225046	210mm	140mm	16.5mm	75mm	105x8mm	RHA-08118 M16 X 48mm
RH-08396 RH-08397	D SERIES	79970 79971	POWER 255012	215mm	140mm	14.5mm	56mm	80x8mm	RHA-08419 M14 X 40mm
				*Tungsten Hard Faced Option available					
<b>FORIGO</b>									
RH-09035 RH-09036	G35 STONE BURIER	G3596100 & 110		A 160mm	B 113mm	14.5mm	48mm	90X8mm	
RH-09037 RH-09038	G45 STONE BURIER	G4595000 & 5100		A 177mm	B 135mm	14.5mm	56mm	100X8mm	
<b>HOWARD</b>		<b>RH-08782 -10 &amp; RH-08783 -10 NEW 10mm THICK OPTION</b> <b>RH-08782 - 10T &amp; RH-08783 - 10T NEW HARD FACED 10mm THICK OPTION</b>							
RH-08396 RH-08397	HR35 - R2 ROTOR	79970 79971	POWER 255012	215mm	140mm	14.5mm	56mm	80X8mm	RHA-08419 M14 X 40mm
				*Tungsten Hard Faced Option available					
RH-08105 RH-08106	R500,HR30,35,E , AR,ST	63604 63605 B4001 / 2	POWER 225026	173mm	142mm	13mm	57mm	90x8mm	RHA-08119 1/2" X 1 1/2 UNF
				*Tungsten Hard Faced Option available					
RH-08007 RH-08008	AH,CH,RC,R600 HR40-3,AH.S.M HR50-61s	9862 / 9863 B7001 / 2	POWER 225025	170mm	137mm	16.5mm	51mm	90x8mm	RHA-08118 M16 X 48mm
				*Tungsten Hard Faced Option available					
RH-08007-10 RH-08008-10	AH,CH,RC,R600 HR40-3,AH.S.M HR50-61s	9862 / 9863 B7001/2	POWER 225084DX	170mm	137mm	16.5mm	51mm	90x10mm	RHA-08118 M16 X 48mm
				*Tungsten Hard Faced Option available					
RH-08110 RH-08111	AH,CH,RC,R600 HR40-3,AH.S.M HR50-61s	9950 / 9951 B9001 / 2	SPEED 225072	210mm	145mm	16.5mm	51mm	90x8mm	RHA-08118 M16 X 48mm
				*Tungsten Hard Faced Option available					
RH-08112 RH-08113	LONG SHANK	9910 / 9911 B9003 / 4	POWER 225024	210mm	137mm	16.5mm	51mm	90x8mm	RHA-08118 M16 X 48mm
				*Tungsten Hard Faced Option available					
RH-08782 RH-08783	H/DUTY HR50, 60,61 F ROTOR	762719 762720 612719/20	POWER 237004	193mm	135mm	16.5mm	75mm	105x8mm	RHA-08118 M16 X 48mm
				*Tungsten Hard Faced Option available					

**NOTE: PLEASE CHECK DIMENSIONS FOR CORRECT BLADES**

# Rotary Hoe Blades

APPLICATION OEM REF TYPE SIZE A SIZE B HOLE CENTRES SECTION BOLT

APPLICATION		OEM REF	TYPE	SIZE A	SIZE B	HOLE	CENTRES	SECTION	BOLT
<b>KRONE &amp; KUHN</b>		RH-08782 -10 & RH-08783 -10 NEW 10mm THICK OPTION RH-08782 - 10T & RH-08783 - 10T NEW HARD FACED 10mm THICK OPTION							
RH-08782 RH-08783	E, EL KUHN RF KRONE	52359600 52359700 52359000/1	POWER 237004	193mm	135mm	16.5mm	75mm	105x8mm	RHA-08118 M16 X 48mm
<i>*Tungsten Hard Faced Option available</i>									
RH-09146 RH-09147	E, EL KUHN RF KRONE		SPEED 225046	210mm	140mm	16.5mm	75mm	105x8mm	RHA-08118 M16 X 48mm
<b>MASCHIO</b>									
RH-08394 RH-08395	B, BI, C & SC SERIES (TERANOVA)	01110427 01110426	SPEED 255013	215mm	140mm	14.5mm	56mm	80x8mm	RHA-08419 M14 X 40mm
RH-08396 RH-08397	B, BI, C & SC SERIES (TERANOVA)	01110429 01110428	POWER 255012	205mm	140mm	14.5mm	56mm	80x8mm	RHA-08419 M14 X 40mm
RH-08398 RH-08399	G SERIES	20100413 20100412	SPEED 255025	257mm	148mm	16.5mm	68mm	90x10mm	RHA-08420 M16 X 58mm
RH-08400 RH-08401	G SERIES	20100415 20100414	POWER 255026	225mm	142mm	16.5mm	68mm	90x10mm	RHA-08420 M16 X 58mm
<i>*Tungsten Hard Faced Option available</i>									
RH-08404 RH-08405	S SERIES	20100404 20100405	POWER 255028	225mm	145mm	16.5mm	56mm	90x8mm	RHA-08420
<i>*Tungsten Hard Faced Option available</i> <i>Check bolt length: RHA-08420, M16 x 58mm or RHA-08118 M16 x 48mm</i>									
RH-09153 RH-09154	PANTERA	09400419 09400418	POWER 255107	215mm	135mm	16.5mm	56mm	90x10mm	RHA-08420
<i>*Tungsten Hard Faced Option available</i> <i>Check bolt length: RHA-08420, M16 x 58mm or RHA-08118 M16 x 48mm</i>									
RH-09371 RH-09372	PANTERA		SPEED 255104	210mm	150mm	16.5mm	56mm	90x10mm	RHA-08420
<i>Check bolt length: RHA-08420, M16 x 58mm or RHA-08118 M16 x 48mm</i>									
<b>SICMA</b>									
RH-08116 RH-08117	SP & RG	S4814516 S4814517 4814002/03	POWER 153016	185mm	135mm	14.5mm	57mm	80x8mm	RHA-08419 M14 X 40mm
<i>*Tungsten Hard Faced Option available</i>									
RH-08243 RH-08244	SP & RG	S4814518 S4814519	SPEED 153015	195mm	135mm	14.5mm	57mm	80x8mm	RHA-08419 M14 X 40mm
<i>*Tungsten Hard Faced Option available</i>									
<b>WECAN</b>									
RH-08116 RH-08117	DGW & MGW LG80HP		POWER 153016	185mm	135mm	14.5mm	57mm	80x8mm	RHA-08419 M14 X 40mm
<i>*Tungsten Hard Faced Option available</i>									
<b>VALENTINI</b>									
RH-09153 RH-09154	ER HERCULES & MAXI SQUALO	4.2-7.7MTR	POWER 255107	215mm	135mm	16.5mm	56mm	90 X 10	RHA-8420
<i>*Tungsten Hard Faced Option available</i> <i>Check bolt length: RHA-08420, M16 x 58mm or RHA-08118 M16 x 48mm</i>									

ASP HOE BLADES ARE SOLD IN EQUAL QUANTITIES OF LEFT & RIGHT HAND.  
OEM REFERENCE NUMBERS ARE FOR IDENTIFICATION ONLY - NOT SOLD AS GENUINE.

# Power Harrow Blades

Sold in equal quantities of left & right hand only.



## PH-08784 & PH-08785

Suits **CELLI**  
ER & Minigo, Go, Laser  
Ranger & Energy  
OEM Ref  
622715  
622716

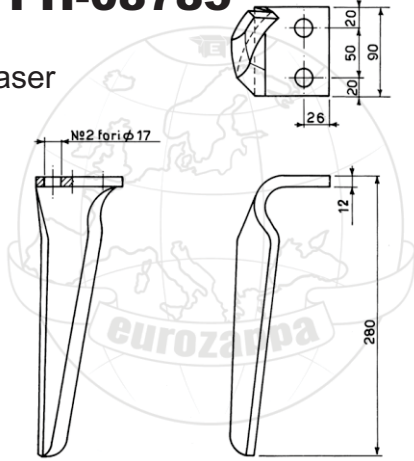

## PH-08786 & PH-08787

Suits **CELLI**  
KR & Maxi  
OEM Ref  
622603  
622604

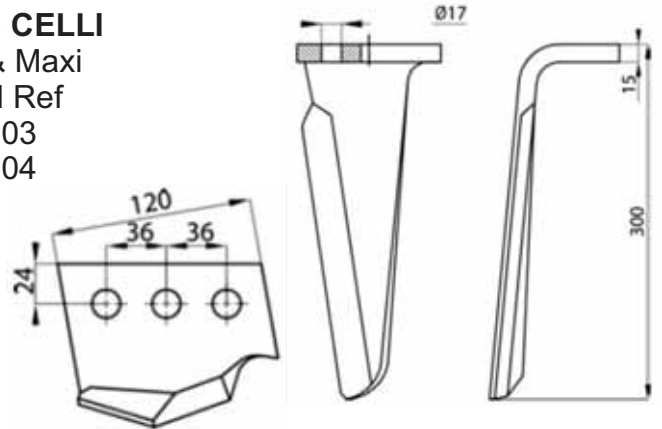

## PH-08796 & PH-08797

Suits **KUHN & EMY**  
HR & HRB  
OEM Ref  
525604  
525605

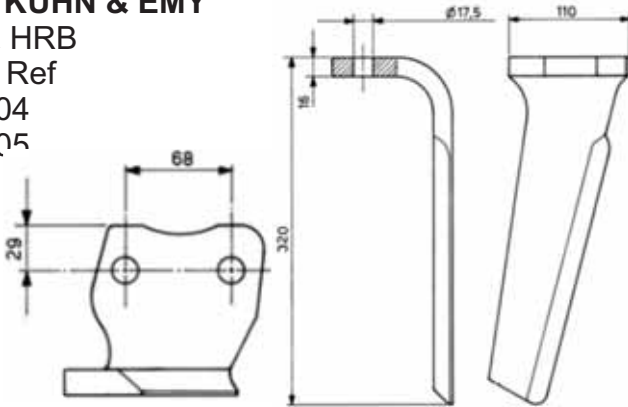

## PH-08798 & PH-08799

Suits **KUHN & EMY**  
HR & HRB  
OEM Ref  
52539400A  
52539500A

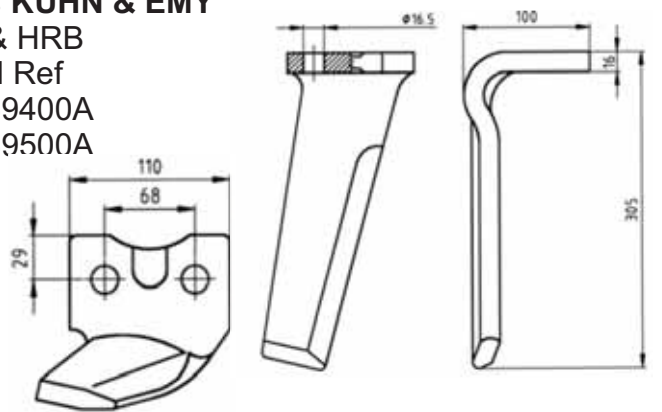

## PH-08800 & PH-08801

Suits **CELLI** (ER, LASER, RANGER, GO ETC)  
**HOWARD** (FALC & FOX), **MASCHIO** DC, DS, DL &  
**SICMA**. OEM Ref  
38100222/23, 512075/76,  
E010146/20146

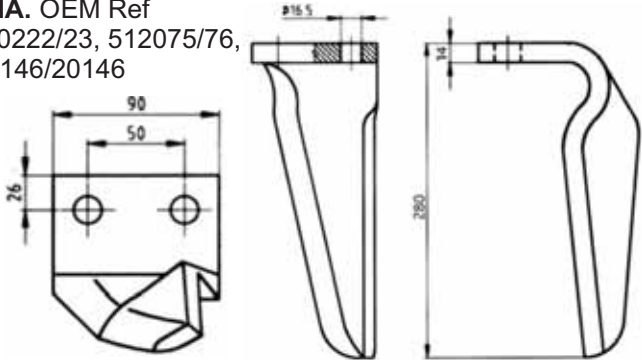

## PH-08802 & PH-08803

Suits **MASCHIO**  
DM & AQUILA  
**BREV. 36100215/6**  
OEM Ref  
36100215/16

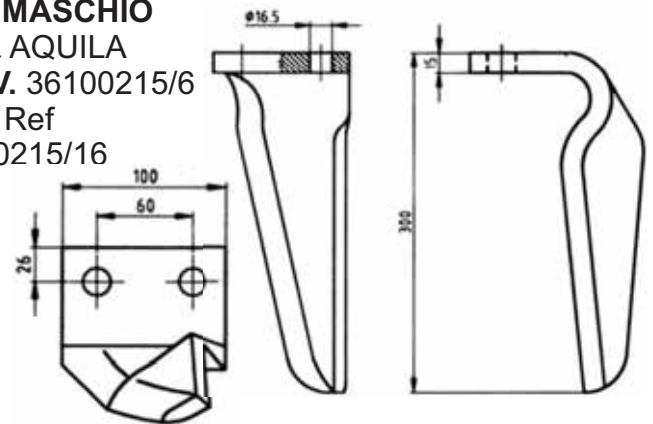

## PH-08930 &

## PH-08931

Suits **AMAZONE**  
OEM Ref 962337  
962338

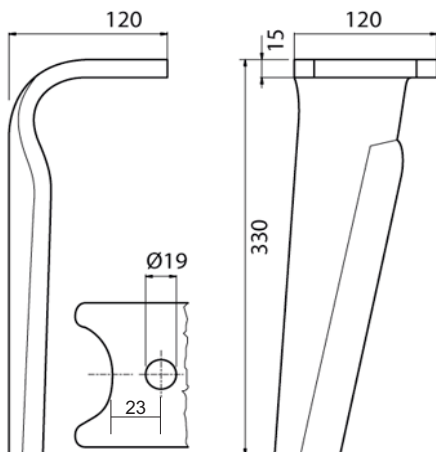

## PH-09221 &

## PH-09222

Suits **LELY - CLUB TINE**  
OEM Ref 116990111 / 112

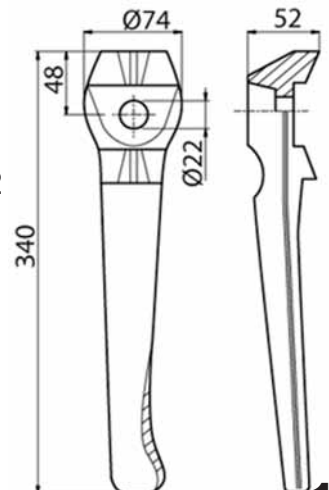

# Power Harrow Blades

## PH-09225 & PH-09226

Suits KUHN  
OEM Ref 52596410  
/ 52596510

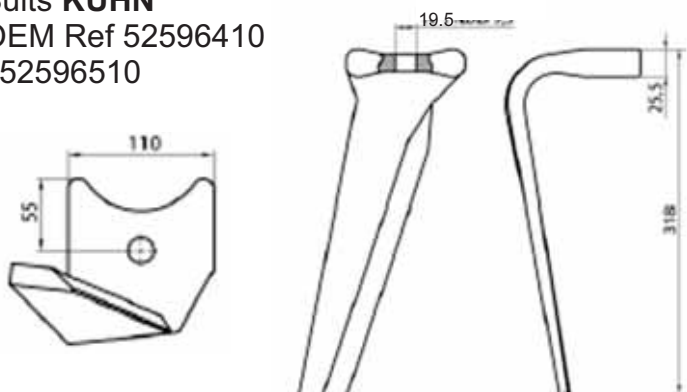

## PH-09227 & PH-09228

Suits KUHN  
OEM Ref K2500090  
/100

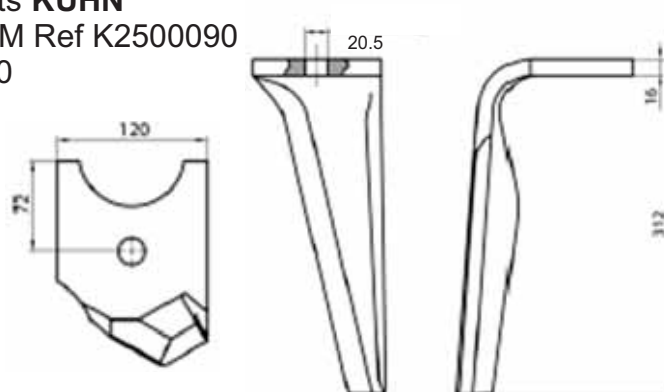

## PH-09266

RINALDI R2 TINE

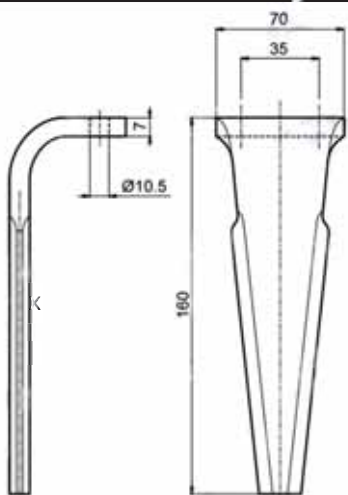

Right Hand

Left Hand



## PHA-08804

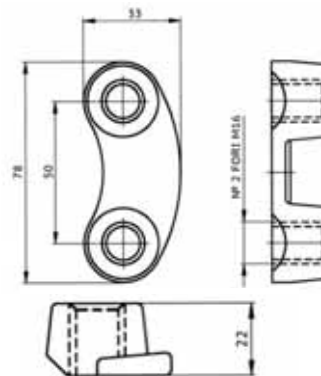

More than 70 years of experience endorse our track record. We are leaders in the production of Discs, Points, Tines, Mouldboards, Blades and Clamps. All our pieces are made with Boron Steel which guarantees the perfect balance between the maximum resistance to wear and flexibility.

## ASP SPEED TILLER DISCS



### AMAZONE

ASP-08903BB20" x 4mm Flat Back, 4 x 12.5mm Holes @ 120mm PCD suit Catros  
ASP-09229BB26" x 6mm Flat Back, 4 x 12.5mm Holes @ 170mm PCD suit Certos

### K-LINE

ASP-1120 22" x 5mm 70mm Round Centre, 4 x 18mm @ 137mm PCD  
ASP-99 24" x 6mm 70mm Round Centre, 4 x 18mm @ 137mm PCD  
ASP-08858 26" x 6mm 70mm Round Centre, 4 x 18mm @ 137mm PCD  
ASP-09000 28" x 6mm 70mm Round Centre, 4 x 18mm @ 137mm PCD - check fitment ?  
**ASP-09380 Jump Arm Rubber Mounts 50mm x 226mm OEM 29000JAX226**

### KUHN

ASP-09295 20" x 5mm Flat Back, 6 x 11mm Sq Holes @ 100mm PCD suit Optimer H2203180  
ASP-09296BB20" x 6mm Flat Back, 6 x 11mm Sq Holes @ 100mm PCD suit Optimer H2234350

### LELY

ASP-09029 22" x 5mm 62mm Round/key, 5 x 14.5mm Holes @113mm PCD OEM 760 020 033

**MASCHIO** (also fits Farnet OEM 3007653 & Norwood Quicktill with SKF BAA Hubs)

ASP-09289BB20" x 5mm Flat Back, 4 x 12.5mm Holes @ 98mm PCD OEM M65400214

### POTTINGER

ASP-09138 22" x 5mm Flat Back, 4 x 12.5mm Holes @ 110mm PCD, 56mm Dish

# Agricultural Discs

ASP Discs are among the finest, longest wearing BORON discs manufactured in the world.

All ASP Discs & Coulters come with a warranty, guaranteeing the user maximum working life.

Don't settle for high carbon steel discs...  
INSIST ON ASP SPANISH BORON STEEL!



## BoronBlue™

Reference Chart - Machine Make

AITCH	AITCHISON	D	DUNCAN	HU	HUTCHMASTER	MIL	MILLER
ALFM	ALFARM	DB	DAVID BROWN	IH	INT. HARVESTER	MSW	MOURILYN
BNL	BONEL	E	ENNOR ENG	JA	JARRETT	NG	NAPIER
BH	BUSH HOG	ES	EASY-FIX	JB	JOHN BERENDS	SH	SHEARER
BR	BIG RIG	EZ	EZEE-ON	JD	JOHN DEERE	SOV	SOVEREIGN
BT	BETTINSON	GZY	GRIZZLY	JK	JANKE	STG	STEIGER
CH	CHAMBERLAIN	GR	GIBBONS	KEL	KELLOW	TW	TAYLORWAY
CL	CLOUGH	GN	GESSNER	KRS	KRAUSE	TNR	TOWNER
CA	CASE	HE	HODGE	MA	MANNUM AG	W	WILLETT
CS	CONNOR SHEA	HB	H-BAGSHAW	MF	MASSEY FERG	WK	WALKER
CW	COUNTRY WIDE	HT	HOLDEN HT	MH	MURRAY	Y	YEOMAN

PART NUMBER	THICK	CONCAVE	CENTER HOLE	CENTER HOLE SIZE MM	RADIAL HOLES	PCD	DESCRIPTION	AGPOINT PART NO	GWT/ McCOY PART NO	KG
<b>SCALLOP &amp; FLUTED DISCS</b>										
<b>18"</b>										
ASP-6C	5 MM	56 MM	DUAL SQUARE	30 MM & 33 MM			NG, JA, BNL	184-092SD	1815-S-8	6
<b>20"</b>										
ASP-12C	4 MM	58 MM	DUAL SQUARE	27 MM & 30 MM			SH,JA,BNL,NG,GR	204-102SD	2015-S-2	6
ASP-08903BB	4 MM FLAT BACK	54 MM	NIL		4 X 12.5 MM	120 MM	AMAZONE CATROS SPEED TILLER			6
ASP-09295	5 MM FLAT BACK	52 MM	NIL		6 X 11 MM	100 MM	KUHN OPTIMER H2203180			
ASP-09296	6 MM FLAT BACK	52 MM	NIL		6 X 11 MM	100 MM	KUHN OPTIMER H2234350			
ASP-13C	4 MM FLAT BACK	45 MM	DUAL SQUARE	27 MM & 30 MM			IH, MF, MH	204-7FSD		6
ASP-09289	5 MM FLAT BACK	54 MM	NIL		4 X 12.5 MM	98 MM	MASCHIO SPEED TILLER 65700201			7
<b>22"</b>										
ASP-34C	4 MM	60 MM	DUAL SQUARE	27 MM & 30 MM			JA, DB			8
ASP-1120	5 MM	63 MM	ROUND	70 MM	4 X 18 MM	137 MM	K-LINE SPEED TILLER & GZY GRUMPY	225-3SB	22044	10
ASP-41C	5 MM	62 MM	DUAL SQUARE	30 MM & 33 MM			NG340, HDGE, BNL, JB			10
ASP-43	5 MM	70 MM	ROUND	70 MM	6 X 18 MM	113 MM	CS, BABY GIANT	225-171SB	2218-SB-1	10
ASP-42C	5 MM FLAT BACK	62 MM	DUAL SQUARE	27 MM & 30 MM			IH 3-4, MF, MH	225-9SFD	2218-SF-1/9	10
ASP-09029	5 MM	60 MM	ROUND - KEY	62 MM	5 X 14.5 MM	113 MM	LELY TULIP			10
ASP-09138	5 MM FLAT BACK	56 MM			4 X 12.5 MM	110 MM	POTTINGER			10
<b>24"</b>										
ASP-92C	5 MM	76 MM	DUAL SQUARE	30 MM & 33 MM			SH 500, NG 690, HDGE 245-288SD	245-226S	2418-S-15	11
ASP-09294BB	5 MM FLAT BACK	70 MM	DUAL SQUARE	27 MM & 30 MM			IH 3-4, MF, MH			11
ASP-100C	6 MM	76 MM	DUAL SQUARE	30 MM & 33 MM			SH, HDGE, BNL, NG, JD, BH	246-43SD	2425-S-37/40	13
ASP-100C-F	6 MM FLUTED	95 MM	DUAL SQUARE	30 MM & 33 MM			SH, HDGE, BNL, NG, JD, BH			13
ASP-101C	6 MM	76 MM	DUAL SQUARE	39 MM & 41 MM			HDGE, BNL, NG, IH, JA, SH, GR670	246-38SD	2425-S-8/38	13
ASP-101C-F	6 MM FLUTED	76 MM	DUAL SQUARE	39 MM & 41 MM			HDGE, BNL, NG, IH, JA, SH, GR670			13
ASP-103	6 MM	84 MM	ROUND	70 MM	6 X 18 MM	113 MM	CS BABY GIANT, CS710, 760, 780	246-1SB	2425-SB-1	13
ASP-99	6 MM	73 MM	ROUND	70 MM	4 X 18 MM	137 MM	K-LINE & GRIZZLY GRUMPY & ROLLA	246-3SB	2425-SB-3	13

# Agricultural Discs

PART NUMBER	THICK	CONCAVE	CENTER HOLE	CENTER HOLE SIZE MM	RADIAL HOLES	PCD	DESCRIPTION	AGPOINT PART NO	GWT/ McCOY PART NO	KG	
<b>SCALLOP &amp; FLUTED DISCS</b>											
<b>26"</b>											
ASP-133	6 MM	57 MM	ROUND	25.4 MM	4 X 18 MM	228 MM	MSW			16	
ASP-138	6 MM	67 MM	ROUND	135 MM	4 X SQ 13.5 MM	228 MM	BNL TRASH INCORP	266-138S		16	
ASP-139	6 MM	89 MM	ROUND	100 MM	6 X 22 MM	185 MM	GRIZZLY & BELMAC	266-26SB	2625-SB-26	16	
ASP-1322	6 MM FLAT BACK	81 MM	SQUARE	39 MM			IH, 770, 590, 501	266-15F	26161	16	
ASP-140	6 MM	91 MM	ROUND	78 MM	6 X 22 MM	190 MM	CS LITTLE GIANT, CS780, E, BNL	266-15B	2625-SB-1	16	
ASP-141C	6 MM	81 MM	DUAL SQUARE	39 MM & 41 MM	KUHN DISC XM2,		HDGE, BNL, NG670, 710-740, JA	266-49SD	2625-S-14/35	16	
ASP-143C	6 MM	91 MM	DUAL SQUARE	54 MM & 60 MM			SH 700, IH3-5	266-16SD	26143C	16	
ASP-143C-F	6 MM	91 MM	DUAL SQUARE	54 MM & 60 MM			SH 700, IH3-5		26143CW	16	
ASP-160C	6 MM	91 MM	DUAL SQUARE	30 MM & 33 MM			JD, HDGE, BNL, BH	266-95D	26160C	16	
ASP-09229BB	6 MM FLAT BACK	54 MM	NIL		4 X 13 MM	170 MM	AMAZONE CERTOS			16	
ASP-160SH	6 MM	60 MM	DUAL SQUARE	30 MM & 33 MM			JD, HDGE, BNL, BH			16	
ASP-08858	6 MM	83 MM	ROUND	70 MM	4 X 18 MM	137 MM	K-LINE, ROCCA IND. & GRUMPY	266-35B		16	
ASP-08858-F	6 MM FLUTED	83 MM	ROUND	70 MM	4 X 18 MM	137 MM	K-LINE SPEED TILLER & GRUMPY			16	
ASP-151	8 MM	89 MM	ROUND	100 MM	6 X 22 MM	185 MM	GRIZZLY & BELMAC	268-25B	2631-SB-2	20	
ASP-152	8 MM	95 MM	ROUND	52 MM			STG, EZ, CW	268-7S	2631-S-3	20	
ASP-153	8 MM	100 MM	ROUND	78 MM	6 X 22 MM	190 MM	CS 780, CS LITTLE GIANT, BNL, E	268-15B	2631-SB-1	20	
ASP-154C	8 MM	81 MM	DUAL SQUARE	39 MM & 41 MM			HDGE, BNL, NG, ALLIS, JA	268-49SD		20	
ASP-155	8 MM	91 MM	ROUND	58 MM			KELLOW	268-155S	2631-S57	20	
ASP-1263	8 MM FLAT BACK	81 MM	SQUARE	39 MM			IH, 770, 590, 501			20	
<b>28"</b>											
ASP-09000	6 MM	81 MM	ROUND	70 MM	4 X 18 MM	137 MM	K-LINE SPEED TILLER			19	
ASP-1178	6 MM	102 MM	DUAL SQUARE	54 MM & 60 MM			IH 3-5, SH700	286-1021S	28185C	19	
ASP-166C	6 MM	69 MM	DUAL SQUARE	39 MM & 41 MM			CN, SH, NG, BNL, HE, JA	286-29SD		19	
ASP-167C	6 MM	102 MM	DUAL SQUARE	39 MM & 41 MM			HDGE, BNL, NG670, JA, SH	286-606SD	2825-S-95	19	
ASP-167C-F	6 MM FLUTED	102 MM	DUAL SQUARE	39 MM & 41 MM			HDGE, BNL, NG670, JA, SH				
ASP-168-S	6 MM	102 MM	ROUND	100 MM	6 X 22 MM	185 MM	GRIZZLY & BELMAC	286-85B	2825-SB-8	19	
ASP-170	6 MM	102 MM	ROUND	78 MM	6 X 22 MM	190 MM	E, BNL, CS, LITTLE GIANT	286-1013S		19	
ASP-168	8 MM	102 MM	ROUND	100 MM	6 X 22 MM	185 MM	GRIZZLY & BELMAC	288-15B	28169S	24	
ASP-171	8 MM	102 MM	ROUND	78 MM	6 X 22 MM	190 MM	E, BNL, CS, LITTLE GIANT	288-1086SB	2831-SB2	24	
ASP-175C	8 MM	102 MM	DUAL SQUARE	39 MM & 41 MM			CS, HDGE, BNL, MSW	288-1073S		24	
ASP-175C-F	8 MM FLUTED	102 MM	DUAL SQUARE	39 MM & 41 MM			CS, HDGE, BNL, MSW				
ASP-178	8 MM	102 MM	ROUND	52 MM			CW, EZE & STG	288-17S		24	
ASP-08981	8 MM	102 MM	ROUND	44 MM	(Suits 1 5/8" Axle ONLY - Use ASP-08968 for 1 3/4" Axle - SAME DISC BUT WITH 46mm HOLE)						24
ASP-179	8 MM FLAT BACK	92 MM	SQUARE	40 MM			IH 770	288-15F	2831-SF-1	24	
<b>30"</b>											
ASP-08812	8 MM	94 MM	ROUND	52 MM			CW			28	
<b>32"</b>											
ASP-190	8 MM FLAT BACK	110 MM	SQUARE	46 MM			IH 780	328-15F	3231-SF-1	33	
ASP-193-C	10 MM	112 MM	SQUARE	59 MM			ALFARM 080, TNR620	3210-10SD	3237-S-10	40	
ASP-1995	10 MM	112 MM	ROUND	100 MM	6 X 22 MM	185 MM	GRIZZLY (10 TEETH)	3210-25B	32199S	40	
<b>36"</b>											
ASP-09262	12 MM	123 MM	ROUND	100 MM	6 X 22 MM	185 MM	GRIZZLY TINY (10 TEETH)	3612-25B		63	
<b>PLAIN DISCS</b>											
<b>14"</b>											
ASP-3C	5 MM	30 MM	ROUND	26 MM	6 X 7 MMSQ	110 MM	PIONEER			4	
<b>28"</b>											
ASP-08561	8 MM FLAT BACK	95 MM	SQUARE	40 MM			IH 770			24	
<b>30"</b>											
ASP-09112	6 MM	100 MM	ROUND	25 MM	NOT HEAT-TREATED, SUITABLE ONLY FOR FIRE PITS						

**ASP CAN MANUFACTURE MOST STYLES & SIZES OF DISCS & COULTERS.  
PLEASE CONTACT US TO DISCUSS YOUR REQUIREMENTS.**

**Ph: 07 3881 3464 or Email: sales@asproducts.com.au**





# Coulters

NUMBER	THICK	STYLE	BEVEL	CENTER HOLE	CENTER HOLE SIZE MM	RADIAL HOLES	PCD	DESCRIPTION	AGPOINT PART NO	GWT PART NO	KG
<b>COULTERS</b>											
<b>10.8"</b>											
ASP-6195	3 MM	PLAIN	DOUBLE	ROUND	72 MM	5 X 9 MM	95 MM	CS 470 DRILLS	C1103	6195	1.5
<b>12.5"</b>											
ASP-6197A	3 MM	PLAIN	DOUBLE	ROUND	52 MM	4 & 6 Multi Hole	10.5mm holes @95mm	DUNCAN	C1208	6281	2
<b>13"</b>											
ASP-08988	3 MM	FLUTED	SINGLE	ROUND	20 MM	6 X 6.7 MM	75 MM	SKFAGRI HUB			2
<b>13.5"</b>											
ASP-6198	3 MM	PLAIN	DOUBLE	ROUND	72 MM	5 X 9 MM	95 MM	CS 470 DRILLS	C1320	6336	2
<b>15"</b>											
ASP-1117	4 MM	15 SCALL	SINGLE	ROUND	45 MM	6 X 8.7 MM	76 MM	AGROWPLOW			4
ASP-1118	4 MM	11 SCALL	SINGLE	ROUND	45 MM	6 X 8.7 MM	76 MM	AGROWPLOW			4
<b>16"</b>											
ASP-6408	3 MM	PLAIN	SINGLE	ROUND	25 MM	6 X 7 MM	73 MM	MASON	C1609		3
ASP-6407/5	5 MM	PLAIN	DOUBLE	ROUND	64 MM	5 X 13 MM	108 MM	HOLDEN HT HUB, Y, GN, CS	C1635	6407	5
<b>18"</b>											
ASP-1011	4 MM	FLUTED	FLUTED	ROUND	63.5 MM	5 X 13 MM	108 MM	HOLDEN HT HUB, YEOMAN	C1860W	6473	5
ASP-6200	5 MM	PLAIN	SINGLE	ROUND	77 MM	4 X 10.5 MM	112 MM	JOHN DEERE OEM N283804	C1870	6480	6
ASP-09132	6 MM	PLAIN	SINGLE	ROUND	64 MM	5 X 13 MM	108 MM	HT, YEOMAN, GN, CS	C1872	6472	6
ASP-08878	6 MM	PLAIN	DOUBLE	ROUND	78 MM	5 X 13 MM	108 MM	SPRING RIDGE ENG	C1874		6
<b>20"</b> <span style="color: red;">NEW</span> 20.5 Inch x 6mm ASP-09350BB coulter with 4 x 17mm C/Sunk holes suit BOSS Eng & Bourgault											
ASP-1171	6 MM	PLAIN	SINGLE	ROUND	64 MM	5 X 13 MM	108 MM	HT, VARIOUS STALK CUTTERS	C2072	6523	10
ASP-08865	6 MM	PLAIN	DOUBLE	ROUND	64 MM	5 X 13 MM	108 MM	Y, HT, GN, CS, GIANT	C2070	6522	10
<b>22"</b>											
ASP-1061 A	5 MM	SCALLOP	SCALLOP	ROUND	74 MM	6 X 13 MM	105 MM CSK	NVI, BAKER			9
ASP-09320BB	6 MM	PLAIN	SINGLE	ROUND	64 MM	5 X 13MM	108 MM	HT, DOUBLE DISC OPENER ETC			12
<b>26"</b>											
ASP-6667	6 MM	PLAIN	DOUBLE	ROUND	47 MM	4 X 18 MM	165 MM	HODGE	C2608		14
ASP-6668	6 MM	PLAIN	DOUBLE	ROUND	51 MM	4 X SQ 14 MM	165 MM CSK	HODGE	C2609		14
ASP-6670	6 MM	PLAIN	DOUBLE	ROUND	102 MM	8 X 13 MM	292 MM	BONEL	C2610		14
ASP-6671	6 MM	PLAIN	DOUBLE	ROUND	64 MM	5 X 13 MM	108 MM	HOLDEN HT HUB, Y, GN, CS	C2612		14
<b>30"</b>											
ASP-6202	6 MM	PLAIN	DOUBLE	ROUND	102 MM	8 X 12 MM	292 MM	BONEL	C3014		20
ASP-6766	6 MM	PLAIN	DOUBLE	ROUND	51.5 MM	4 X 18 MM	165 MM	HODGE & GESSNER	C3015		20
ASP-6202/8	8 MM	PLAIN	DOUBLE	ROUND	102 MM	8 X 12 MM	292 MM	BONEL	C3014		28
ASP-6766/8	8 MM	PLAIN	DOUBLE	ROUND	51.5 MM	4 X 18 MM	166 MM	HODGE & GESSNER	C3015		28

**NEW ASP-6766/10BB & ASP-6202/10BB 10mm thick coulters now available**

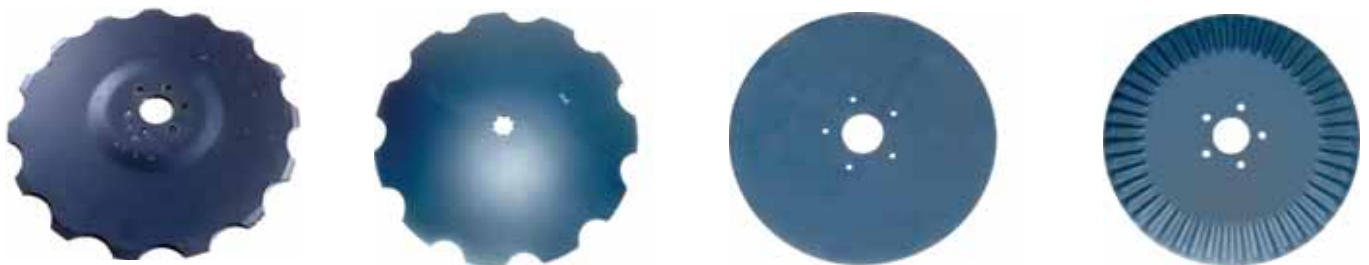

*OEM & Competitors part numbers are for reference only. ASP encourages you to measure your Discs & Coulters prior to ordering.*

# Slasher Blades

**AGRIFARM**



BoronBlue™



Part Number	Description	LENGTH	HOLE	WIDTH	THICK	STEP
BS-01724	Suction Lift Blade Left hand cut  BSA-00179 Bush BSA-09081 Bolt & Nut	355MM	32MM	75MM	12MM	40MM



## BEN WYE

Part Number	Description	LENGTH	HOLE	WIDTH	THICK	STEP
BS-01724	Suction Lift Blade, Left hand cut BSA-00179 Bush BSA-100673 Bolt BSA-100852 Nut	355MM	32MM	75MM	12MM	40MM
BS-01724R	Suction Lift Blade, Right hand cut BSA-00179 Bush BSA-100673 Bolt BSA-100852 Nut	355MM	32MM	75MM	12MM	40MM



## BERENDS(John Berends Implements)

Part Number	Description	LENGTH	HOLE	WIDTH	THICK	STEP
BS-02003	Standard step down blade to suit 6 & 7' EHD Left hand cut, OEM Ref: 2003 BSA-02003B BUSH BSA-PG1112 BOLT BSA-PG1113 NUT	465MM	38MM	100MM	12MM	25MM
BS-02000	Standard step down blade to suit 6' HD Double edge LH & RH OEM Ref: 2000, 2005 BSA-00178 BUSH BSA-PG1112 BOLT BSA-PG1113 NUT	495MM	32MM	75MM	10MM	25MM
BS-01602	Suction Lift blade to suit 6' Side Discharge Left hand cut, OEM Ref: 1987 BSA-00180 BUSH BSA-PG1112 BOLT BSA-PG1113 NUT	460MM	32MM	75MM	16MM	40MM
BS-01585	Flat reversible blade to suit 6' HD Left hand cut, OEM Ref: 1984 BSA-00178 BUSH BSA-PG1112 BOLT BSA-PG1113 NUT	495MM	32MM	75MM	10MM	N/A
BS-01981	Flat reversible blade to suit 4'6" & 5' HD Left hand cut, OEM Ref: 1981 BSA-01981B BUSH BSA-PG1112 BOLT BSA-PG1113 NUT	368MM	26MM	75MM	10MM	N/A



Part Number	Description	LENGTH	HOLE	WIDTH	THICK	STEP
BS-04457	Standard step down blade to suit EP slashers Left hand cut, OEM Ref: 1980, B6005 <b>BSA-04457B</b> BUSH <b>BSA-PG1112</b> BOLT <b>BSA-PG1113</b> NUT	262MM	25MM	65MM	8MM	25MM
BS-01582	Standard step down blade to suit Pasture Toppers Left hand cut, OEM Ref: 1801 <b>BSA-00175</b> BUSH <b>BRA-100196</b> BOLT <b>BSA-100285</b> NUT	275MM	25MM	65MM	7MM	38MM

## CHRIS GROW & GASON

Part Number	Description	LENGTH	HOLE	WIDTH	THICK	STEP
BS-09043	Double Edge blade to suit 5' & Multi Gearbox OEM Ref: 225803 <b>BSA-00178</b> BUSH <b>BSA-100675</b> BOLT <b>BSA-100852</b> NUT	250MM	32MM	100MM	10MM	40MM
BS-09044	Double Edge blade to suit 5' & Multi Gearbox OEM Ref: 226572 <b>BSA-00179</b> BUSH <b>BSA-100675</b> BOLT <b>BSA-100852</b> NUT	350MM	32MM	100MM	13MM	40MM
BS-09045	Double Edge blade to suit 6' & Multi Gearbox OEM Ref: 224936 <b>BSA-00179</b> BUSH <b>BSA-100675</b> BOLT (BSA-S3393, 4" bolt for Mulch setup) <b>BSA-100852</b> NUT	450MM	32MM	100MM	13MM	40MM
BS-09047	Suction Lift blades (10mm thick) to suit 5' & Multi Gearbox OEM Ref: 226571 RH & 226570 LH <b>BSA-00178</b> BUSH <b>BSA-100675</b> BOLT <b>BSA-100852</b> NUT	250MM	32MM	100MM	10MM	70MM
Right Hand Cut						
BS-09046	Left Hand Cut					
BS-08923	Suction Lift blades (10mm thick) to suit 5' & Multi Gearbox OEM Ref: MC1525/1625, 226427LH & 226428 RH <b>BSA-00178</b> BUSH <b>BSA-100675</b> BOLT <b>BSA-100852</b> NUT	357MM	32MM	100MM	10MM	70MM
Right Hand Cut						
BS-08922	Left Hand Cut					
BS-09048	Suction Lift blade to suit 6' & Multi Gearbox OEM Ref: 225159 (RH) & 225158 (LH) <b>BSA-00178</b> BUSH <b>BSA-100675</b> BOLT <b>BSA-100852</b> NUT	450MM	32MM	100MM	10MM	75MM
Right Hand Cut						
BS-09049	Left Hand Cut					
BS-09050	Suction Lift blades (13mm thick) to suit 5' & Multi Gearbox OEM Ref: 226569 RH & 226568 LH <b>BSA-00179</b> BUSH <b>BSA-100675</b> BOLT <b>BSA-100852</b> NUT	250MM	32MM	100MM	13MM	70MM
Right Hand Cut						
BS-09051	Left Hand Cut					
BS-08226	Suction Lift blades to suit 5' & Multi Gearbox OEM Ref: Mc1520 226511(RH) & Mc1620 226512(LH) <b>BSA-00179</b> BUSH <b>BSA-100675</b> BOLT <b>BSA-100852</b> NUT	357MM	32MM	100MM	13MM	60MM
Right Hand Cut						
BS-08227	Left Hand Cut					

Part Number	Description	LENGTH	HOLE	WIDTH	THICK	STEP
BS-08228 Right Hand Cut	Suction Lift blade to suit 6' & Multi Gearbox OEM Ref: Mc1500, 223542 (RH) & Mc1600, 223543 (LH)	450MM	32MM	100MM	13MM	65MM
BS-08229 Left Hand Cut	<b>BSA-00179</b> BUSH <b>BSA-100675</b> BOLT <b>BSA-100852</b> NUT					



## DAKEN

Part Number	Description	LENGTH	HOLE	WIDTH	THICK	STEP
BS-00467	Twisted double edge blade to suit 5' Left hand cut, OEM Ref: <b>BSA-06394B</b> BUSH <b>BSA-07453K</b> BOLT & NUT KIT (1 bolt & 1 nut)	330MM	38MM	100MM	10MM	N/A
BS-01724	Suction Lift blade to suit 6' Left hand cut - "Will only suit certain Models" <b>BSA-00179</b> BUSH <b>BSA-100675</b> BOLT <b>BSA-100852</b> NUT	355MM	32MM	75MM	12MM	40MM
BS-01583	Suction Lift blade to suit 759 Series slashers Left hand cut, OEM Ref: 55475DC Bare-co B6000 <b>BSA-00178</b> BUSH <b>BSA-100675</b> BOLT <b>BSA-100852</b> NUT	485MM	32MM	75MM	10MM	45MM

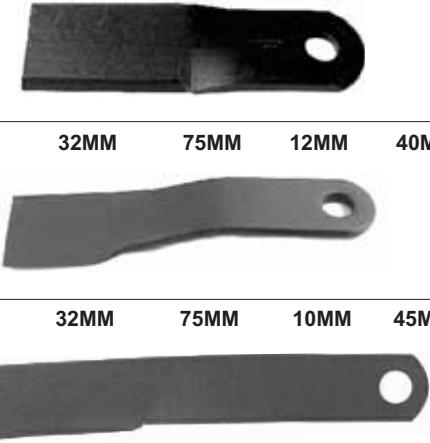

## DIGGA

Part Number	Description	LENGTH	HOLE	WIDTH	THICK	STEP
BS-09271	Step, Double edge blade Suit 1500 & 1800 Skid Steer <b>BSA-09272</b> BOLT & NUT	350MM	38MM	100MM	13MM	40MM



## GESSNER

Part Number	Description	LENGTH	HOLE	WIDTH	THICK	STEP
BS-01586	Standard Step down blade to suit 15'6" & 21'6" Double edge LH & RH <b>BSA-00175</b> BUSH <b>BSA-08089</b> BOLT KIT (1x bolt, bush & nut)	250MM	25MM	65MM	7MM	22MM

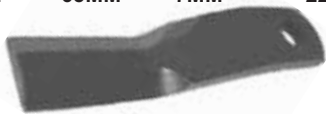

# FIELDQUIP - Including BUSH HOG & RHINO

Part Number	Description	LENGTH	HOLE	WIDTH	THICK	STEP
BS-01583	Suction Lift blade suit LE60, 70 & LS70 slashers L/Hand cut, OEM Ref: 21003, FQ6000, B6000 <b>BSA-00178</b> BUSH <b>BSA-100675</b> BOLT <b>BSA-100852</b> NUT	490MM	32MM	75MM	10MM	45MM
BS-09075	Stepped & Fluted blade suit 5ft deck Bush Hog Ls1500 & LH1500 OEM Ref 36BH, 7555BH Left Hand cut <b>BSA-09087</b> Bolt Kit OEM Ref 7919BH	563MM	38MM	75MM	12MM	50MM
BS-08141	Stepped & Fluted blade suit 6ft deck Bush hog Ls1800 OEM Ref 7556BH, 19160 Left Hand cut <b>BSA-09087</b> Bolt Kit OEM Ref 7919BH	645MM	38MM	100MM	13MM	58MM
BS-09076	Stepped & Fluted blade suit 7ft deck Bush Hog Ls2100 & LH2100 OEM Ref 7557BH Left Hand cut <b>BSA-09087</b> Bolt Kit OEM Ref 7919BH	714MM	38MM	100MM	13MM	58MM
BS-08139	Stepped & Fluted blade suit RH272 & RH472 OEM Ref 00780882 Left Hand cut  <b>BSA-09087 Bolt Kit.</b> 1 1/8" thread, 75mm long from under head, 37.5mm x 14mm wide blade shank. Replaces key style bolt as has 2 flats on head for fitment / removal.	571MM	38MM	100MM	13MM	58MM
BS-08923	Suction Lift blades (10mm thick) to suit GEARMOWER GM30-900 etc  <b>BSA-07453K</b> BOLT & NUT <b>BSA-09385</b> BUSH	357MM	32MM	100MM	10MM	70MM
BS-08922	Left Hand Cut	BS-08923				BS-08922

## NOTES

---



---



---



---



---



---

# HIMAC

Part Number	Description	LENGTH	HOLE	WIDTH	THICK	STEP
BS-09366	Suction Lift blade suit HiMac Slashers OEM Ref BLADESL Left Hand cut Use <b>BSA-09367</b> Bolt, Nut & Washer	495MM	32MM	75MM	10MM	55MM
BS-09264	Stepped Double Edge blade suit BrushCutters OEM Ref BLADESLBCO, SB60 Use <b>BSA-09368</b> Bolt, Nut & Washer	415MM	38MM	100MM	12MM	65MM

## Looking for a cheaper blade option?

ASP manufactures the following 3 blades in a standard Spring Steel. Whilst they are not to the same quality standards of our European Boron blades, they are comparative to many ASP competitors blades and are priced accordingly!

**BS-01583BC** suits Daken, Fieldquip, Himac & Jarrett etc  
**BS-01724BC** suits Agrifarm, Ben Wye, Daken, Howard & Kanga  
**BS-08743BC** suits HD & EHD Howard etc

(Also available in kits to suit Howard **BS-78663KBC** & **BS-08743KBC**)



**ALL SLASHER BLADE LENGTH DIMENSIONS ARE FROM THE CENTRE OF THE BOLT HOLE TO THE END OF THE BLADE.**

# HOWARD

Part Number	Description	LENGTH	HOLE	WIDTH	THICK	STEP
BSA-78299K	NIB Style bolt, bush & nut OEM 78299 Single NIB under head					
BS-01572	Twisted double edge blade to suit 6' Left hand cut, OEM Ref: 73955, Bare-co B50 <b>BSA-78299K</b> Nib style bolt kit <b>BSA-74222K</b> Square shank bolt kit	432MM	32MM	75MM	12MM	N/A
BS-01573	Twisted double edge blade to suit 5' Left hand cut, OEM Ref: 72900, Bare-co B6001 <b>BSA-78299K</b> Nib style bolt kit <b>BSA-74222K</b> Square shank bolt kit	280MM	32MM	75MM	12MM	N/A

Part Number	Description	LENGTH	HOLE	WIDTH	THICK	STEP
BS-09281	H/Duty blade suit EHD240 & EHD240E, XHD240 Left hand cut, OEM Ref: 613400	510MM	32MM	100MM	12MM	45MM
	<b>BSA-78299K</b> Nib style bolt kit (Inc. Bush) <b>BSA-00179</b> Bush					
BS-01574	Stepped down double edge blade to suit 6', Hd240, EHDE300 & EHD360 TWIN L/H & R/H cut, OEM Ref: 74598A	355MM	32MM	75MM	12MM	40MM
	<b>BSA-78299K</b> Nib style bolt kit <b>BSA-74222K</b> Square shank bolt kit					
BS-01724 LEFT HAND	Suction lift blade to suit 5', 6' & 7' Nugget & HD etc OEM Ref: 78663, Bare-co B6002	355MM	32MM	75MM	12MM	40MM
BS-01724R RIGHT HAND						
	<b>BSA-78299K</b> Nib style bolt kit (Inc. Bush) <b>BSA-74222K</b> Square shank bolt kit (Inc. Bush) <b>BSA-09321</b> Hex Bolt Kit suit Nugget etc (Inc. Bush) <b>BSA-00179</b> Bush					
<b>BS-78663K</b> Blade & Nib Bolt Kit	Suction lift blade kit to suit 5', 6' & 7' slashers with Nib Style Beams EHD E180 & 210 Left hand cut, OEM Ref: 78663KN KIT INCLUDES 2 X BS-01724 BLADES & 2 X BSA-78299K NIB BOLT KITS	355MM	32MM	75MM	12MM	40MM
<b>BS-78663KHEX</b> Blade & Hex Head Bolt Kit	Suction lift blade kit to suit <b>NUGGET</b> 120, 135, 150L, 150, 180 & 210 & MD120B, Nug120, HS30 Left hand cut, OEM Ref: 78663KH KIT INCLUDES 2 X BS-01724 BLADES & 2 X Hex Head Bolts, Bushes & Nyloc Nuts	355MM	32MM	75MM	12MM	40MM
BS-08743	Leading Edge blade alternative Left hand cut, OEM Ref: 78787, Bare-co B6004	355MM	32MM	90MM	12MM	40MM
	<b>BSA-78299K</b> Nib style bolt kit (Inc. Bush) <b>BSA-00179</b> Bush					
<b>BS-08743K</b> Blade & Nib Bolt Kit	Leading Edge blade kit alternative Left hand cut, OEM Ref: 78787KN <b>Suits HD &amp; EHD 150, 180 &amp; 210</b> KIT INCLUDES 2 X BS-08743 BLADES & 2 X BSA-78299K NIB BOLT KITS	355MM	32MM	90MM	12MM	40MM
BSA-00484	Nib style Beam / Head flat to suit 5 foot slasher OEM Ref: 78818 <b>USE BSA-00480 SPACER</b>	812MM	N/A	130MM	10MM	N/A
SUITS HD150, EHD150, HD300B & EHD300	<b>BSA-74808K</b> Mounting bolt kit (4 bolts & nuts) <b>BSA-100673</b> Beam to spacer bolt (require 2) <b>BSA-100852</b> Beam to spacer nut (require 2)					
						<i>Beam length is from blade bolt hole centres</i>
BSA-00486	Nib style Beam / Head flat to suit 6 foot slasher OEM Ref: 78816 <b>USE BSA-00479 SPACER</b>	1116MM	N/A	130MM	10MM	N/A
SUITS HD180, EHD180 & EHD360	<b>BSA-74808K</b> Mounting bolt kit (4 bolts & nuts) <b>BSA-100673</b> Beam to spacer bolt (require 2) <b>BSA-100852</b> Beam to spacer nut (require 2)					
						<i>Beam length is from blade bolt hole centres</i>
BSA-00489	Nib style Beam / Head flat to suit 7 foot slasher OEM Ref: 78814 <b>USE BSA-00478 SPACER</b>	1414MM	N/A	130MM	10MM	N/A
SUITS HD210 & EHD210	<b>BSA-74808K</b> Mounting bolt kit (4 bolts & nuts) <b>BSA-100673</b> Beam to spacer bolt (require 2) <b>BSA-100852</b> Beam to spacer nut (require 2)					
						<i>Beam length is from blade bolt hole centres</i>
<b>SPACER BEAMS</b>						
<b>BSA-00480</b>	suit BSA-00484 Beams OEM 78734 (722 x 130 x 12mm)					
<b>BSA-00479</b>	suit BSA-00486 Beams OEM 78732 (1026 x 130 x 12mm)					
<b>BSA-00478</b>	suit BSA-00489 Beams OEM 78693 (1314 x 130 x 12mm)					

# JARRETT

Part Number	Description	LENGTH	HOLE	WIDTH	THICK	STEP
BS-01075	Heavy Duty stepped down blade to suit 6' Left hand cut, OEM Ref: 21353  Can use BS-07805 Suction Lift Style Blade. Bolts are not available, they are Genuine only.	560MM	45MM	100MM	13MM	45MM
BS-01583	Suction Lift blade to suit 4' to 6' slashers Left hand cut, OEM Ref: 21003, Bare-co B6000 <b>BSA-00178</b> BUSH <b>BSA-100675</b> BOLT <b>BSA-100852</b> NUT	490MM	32MM	75MM	10MM	45MM
BS-01582	Standard step down blade to suit 1mtr & 4' Left hand cut, OEM Ref: 21010 <b>BSA-21008</b> BOLT <b>BSA-100852</b> NUT	275MM	25MM	65MM	7MM	38MM



# KANGA

Part Number	Description	LENGTH	HOLE	WIDTH	THICK	STEP
BS-00467	Twisted double edge blade to suit S, M, H & XH Left hand cut, OEM Ref: 21016 <b>BSA-06394B</b> BUSH <b>BSA-07453K</b> BOLT & NUT KIT (1 bolt & 1 nut)	330MM	38MM	100MM	10MM	N/A
BS-01724	Suction Lift blade to suit 6' & 7' etc Left hand cut - Replaces OEM 100-134, ASP blade has different hole size - Must use with fasteners below: <b>OPTION 1</b> <b>BSA-00179</b> 3/4" ID BUSH <b>BSA-100675</b> 3/4" HEX BOLT <b>BSA-100852</b> 3/4" NUT <b>OPTION 2</b> <b>BSA-00190</b> 7/8" ID BUSH OEM REF 100-136 <b>BSA-07453K</b> 7/8" HEX BOLT / NUT <b>OPTION 3</b> <b>BSA-09027</b> C/SUNK, SQUARE SHANK BOLT KIT OEM REF 100-135	355MM	32MM	75MM	12MM	40MM

# LOXTON

Part Number	Description	LENGTH	HOLE	WIDTH	THICK	STEP
BS-07652	Flat double edge blade LH & RH cut, OEM Ref: SL056 <b>BSA-07659</b> BUSH <b>BSA-07658</b> BOLT KIT (1 x bolt, nut & bracket)	238MM	23MM	65MM	8MM	N/A
BS-07615	Standard step down double edge blade LH & RH cut, OEM Ref: SL057 <b>BSA-07659</b> BUSH <b>BSA-07658</b> BOLT KIT (1 x bolt, nut & bracket)	238MM	23MM	65MM	8MM	22MM
BS-07653 RIGHT HAND	Suction Lift blade Right hand cut, OEM Ref: SLP054 Left hand cut, OEM Ref: SLP055	238MM	23MM	65MM	8MM	15MM
BS-07654 LEFT HAND	<b>BSA-07659</b> BUSH <b>BSA-07658</b> BOLT KIT (1 x bolt, nut & bracket)					



Part Number	Description	LENGTH	HOLE	WIDTH	THICK	STEP
BS-09339	Major Cyclone MJ30 - 280, 350, 420 & 560 Overlap Blade <b>Use with:</b> BSA-09340 BOLT, BSA-09341 BUSH, BSA-09342 DISC SPRING WASHER (2 PER BLADE) & BSA-09363 NYLOC NUT.	175MM	25MM	75MM	8MM	
BS-09343	Major Cyclone MJ30 - 280, 350, 420 & 560 Left Hand Cut Step blade OEM 27025T-10AC <b>Use with:</b> BSA-09345 BLADE BOLT, BSA-09363 NYLOC NUT, BSA-09346 BUSH, BSA-09342 DISC SPRING WASHER (2 PER BLADE REQUIRED)	235MM	25MM	80MM	10MM	
BS-09344	Major Cyclone MJ30 - 280, 350, 420 & 560 Right Hand Cut blade <b>Use with:</b> BSA-09345 BLADE BOLT, BSA-09363 NYLOC NUT, BSA-09346 BUSH, BSA-09342 DISC SPRING WASHER (2 PER BLADE REQUIRED)	235MM	25MM	80MM	10MM	

## McLEOD / MF

Part Number	Description	LENGTH	HOLE	WIDTH	THICK	STEP
BS-01075	Heavy Duty stepped down blade to suit 6' Left hand cut <b>BSA-01074</b> BUSH <b>BSA-700427</b> 1" PIN <b>BSA-700430</b> NUT	560MM	45MM	100MM	13MM	45MM
BS-07805	Suction lift blade to suit 6' Left hand cut <b>BSA-01074</b> BUSH <b>BSA-700427</b> 1" PIN <b>BSA-700430</b> NUT	560MM	45MM	100MM	13MM	45MM
BS-00986	Stepped down blade to suit 5' Left hand cut <b>BSA-01073</b> BUSH <b>BSA-700419</b> 7/8" PIN <b>BSA-700423</b> NUT	495MM	35MM	75MM	13MM	40MM
BS-1138	Heavy Duty stepped down blade to suit 5' Left hand cut <b>BSA-01074</b> BUSH <b>BSA-700427</b> 1" PIN <b>BSA-700430</b> NUT	495MM	45MM	100MM	13MM	45MM
BS-07161	Stepped down Double edge blade to suit 4' Left & Right hand cut <b>BSA-07161B</b> BUSH <b>BSA-700419</b> 7/8" PIN <b>BSA-700423</b> NUT	331MM	38MM	100MM	10MM	47MM

Fasteners to suit McLeod with 7/8" PIN

<b>BSA-700420</b> CUP	<b>BSA-700419</b> 7/8" PIN
<b>BSA-700421</b> BOSS	<b>BSA-700423</b> 7/8" NUT
<b>BSA-701962</b> KEY	<b>BSA-01073</b> BUSH
<b>BSA-700494</b> CLUTCH DISC	151mm X 57mm X 4.7mm THICK

Fasteners to suit McLeod with 1" PIN

<b>BSA-700428</b> CUP	<b>BSA-700427</b> 1" PIN
<b>BSA-700431</b> BOSS	<b>BSA-700430</b> 1" NUT
<b>BSA-701962</b> KEY	<b>BSA-01074</b> BUSH
<b>BSA-700494</b> CLUTCH DISC	151mm X 57mm X 4.7mm THICK

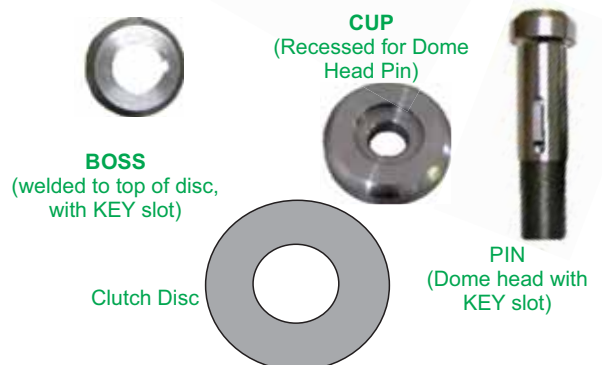









Part Number	Description	LENGTH	HOLE	WIDTH	THICK	STEP
BS-08138 RIGHT HAND	Stepped & Fluted blade, Right Hand cut, OEM Ref 401-046A, 401-026 <i>(can use with <b>BS-09088</b> Flat Blade)</i>	571MM	38MM	100MM	13MM	58MM
BS-08139 LEFT HAND	Stepped & Fluted blade, Left Hand cut, OEM Ref 401-047A, 401-027 <i>(can use with <b>BS-09088</b> Flat Blade)</i>	571MM	38MM	100MM	13MM	58MM
BS-08140 RIGHT HAND	Stepped & Fluted blade. Right Hand cut, OEM Ref 401-049A, 401-032 <i>(Can use with <b>BS-08959</b> flat blade)</i>	645MM	38MM	100MM	13MM	58MM
BS-08141 LEFT HAND	Stepped & Fluted blade Left Hand cut, OEM Ref 401-048A, 401-028 <i>(Can use with <b>BS-08959</b> flat blade)</i>	645MM	38MM	100MM	13MM	58MM
BS-09088	<b>Mulch Blade.</b> Flat double edge for both Left & Right hand cut, Use with BS-08138 & BS-08139 blades. 571mm LONG, 75mm WIDE X 10mm THICK					
BS-08959	<b>Mulch Blade.</b> Flat double edge for both Left & Right hand cut, Use with BS-08140 & BS-08141 blades 645mm LONG, 75mm WIDE X 10mm THICK					



**SCHULTE BOLT  
BSA-09094K BOLT & NUT  
WILL ONLY SUIT MULCH BLADE  
SET UP. IT HAS A 7/8" SHANK TO  
SUIT THE 2 BLADES. WILL NOT  
SUIT A SINGLE BLADE.**

## SUPERIOR & PAGE

Part Number	Description	LENGTH	HOLE	WIDTH	THICK	STEP
BS-01586	Standard step down double edge blade LH & RH cut, OEM Ref: S3608 <b>BSA-00175</b> BUSH <b>BSA-08089</b> BOLT KIT <i>(bolt kit includes 1x bolt, bush &amp; nut)</i>	250MM	25MM	65MM	7MM	22MM
BS-P1927	Flat reversible blade Left hand cut, OEM Ref: S2427 <b>BSA-00178</b> BUSH <b>BSA-08042</b> BOLT KIT <i>(bolt kit includes 1x Dome head bolt, bush &amp; nut)</i>	305MM	32MM	75MM	10MM	N/A
BS-P1938/10	Standard step down double edge blade LH & RH cut, OEM Ref: S4065, P1938 <b>BSA-00178</b> BUSH <b>BSA-08042</b> BOLT KIT <i>(bolt kit includes 1x Dome head bolt, bush &amp; nut)</i>	305MM	32MM	75MM	10MM	40MM
BS-01599	Flat reversible blade to suit 5' Left hand cut, OEM Ref: S4062, P1502 <b>BSA-00180</b> BUSH <b>BSA-S2115K</b> BOLT KIT <i>(bolt kit includes 1x Dome head bolt, bush &amp; nut)</i>	305MM	32MM	75MM	16MM	N/A
BS-00797	Standard step down double edge blade to suit 5' LH & RH cut, OEM Ref: S4600, P4073 <b>BSA-00180</b> BUSH <b>BSA-S2115K</b> BOLT KIT <i>(bolt kit includes 1x Dome head bolt, bush &amp; nut)</i>	305MM	32MM	75MM	16MM	40MM

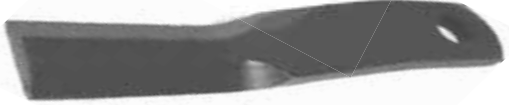
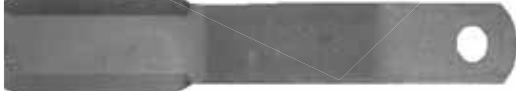
Part Number	Description	LENGTH	HOLE	WIDTH	THICK	STEP
BS-01601	Suction lift blade to suit 5' & Multi Gearbox Left hand cut, OEM Ref: S4064, P1503, S4090 <b>BSA-00180</b> BUSH <b>BSA-S2115K</b> BOLT KIT (bolt kit includes 1x Dome head bolt, bush & nut)	305MM	32MM	75MM	16MM	40MM
						
BS-01601R	Suction lift blade to suit 5' & Multi Gearbox Right hand cut, OEM Ref: S4091 <b>BSA-00180</b> BUSH <b>BSA-S2115K</b> BOLT KIT (bolt kit includes 1x Dome head bolt, bush & nut)	305MM	32MM	75MM	16MM	40MM
						
BS-S2428	Flat reversible blade to suit 6' Left hand cut, OEM Ref: S2428 <b>BSA-00178</b> BUSH <b>BSA-08042</b> BOLT KIT (bolt kit includes 1x Dome head bolt, bush & nut)	460MM	32MM	75MM	10MM	N/A
						
BS-P2028	Standard step down double edge blade to suit 6' LH & RH cut, OEM Ref: S6064, P2028, S2424 <b>BSA-00178</b> BUSH <b>BSA-08042</b> BOLT KIT (bolt kit includes 1x Dome head bolt, bush & nut)	460MM	32MM	75MM	10MM	40MM
						
BS-01600	Flat reversible blade to suit 6' & 7' Left hand cut, OEM Ref: S5062, P1584, P4098 <b>BSA-00180</b> BUSH <b>BSA-S2115K</b> BOLT KIT (bolt kit includes 1x Dome head bolt, bush & nut)	460MM	32MM	75MM	16MM	N/A
						
BS-01602	Suction Lift blade to suit 6' & 7' Left hand cut, OEM Ref: S5064, S5061, P1585 <b>BSA-00180</b> BUSH <b>BSA-S2115K</b> BOLT KIT (bolt kit includes 1x Dome head bolt, bush & nut)	460MM	32MM	75MM	16MM	40MM
						
BS-01602R	Suction Lift blade to suit 6' & 7' Right hand cut, OEM Ref: S5065, S2116 <b>BSA-00180</b> BUSH <b>BSA-S2115K</b> BOLT KIT (bolt kit includes 1x Dome head bolt, bush & nut)	460MM	32MM	75MM	16MM	40MM
						
BS-01603	Standard step down blade to suit 6' & 7' Left hand cut, OEM Ref: S5063 <b>BSA-00180</b> BUSH <b>BSA-S2115K</b> BOLT KIT (bolt kit includes 1x Dome head bolt, bush & nut)	460MM	32MM	75MM	16MM	40MM
						
BS-01604	Standard step down double edge blade to suit 6' & 7' LH/RH cut, OEM S2142, P4099 Bare-co B6999 <b>BSA-00180</b> BUSH <b>BSA-S2115K</b> BOLT KIT (bolt kit includes 1x Dome head bolt, bush & nut)	460MM	32MM	75MM	16MM	40MM
						
BS-01606	Large step down double edge blade to suit 6' & 7' LH & RH cut, OEM Ref: S2143, S2164 <b>BSA-00180</b> BUSH <b>BSA-S2115K</b> BOLT KIT (bolt kit includes 1x Dome head bolt, bush & nut)	460MM	32MM	75MM	16MM	75MM
						

Beam length is from centre of blade bolt holes  
 LENGTH HOLE WIDTH THICK STEP

**PLEASE NOTE: ALL BEAM LENGTH MEASUREMENTS ARE TAKEN FROM THE CENTRE OF THE BLADE BOLT HOLES...NOT AN OVERALL LENGTH. PLEASE CHECK MOUNTING HOLE CENTRES.**

<b>BSA-S4058</b>	Superior beam / head flat to suit 4' & 4'6" with <u>round holes</u> . 20mm mounting bolt holes @ 152mm centres. <b>BSA-S3393</b> MOUNTING BOLT (require 2) <b>BSA-100852</b> NUT (require 2)	609MM	N/A	75MM	10MM	N/A
------------------	--	-------	-----	------	------	-----



<b>BSA-S2112</b>	Superior beam / head flat to suit 4' & 4'6" with <u>square holes</u> . 20mm mounting bolt holes @ 152mm centres. <b>BSA-S3393</b> MOUNTING BOLT (require 2) <b>BSA-100852</b> NUT (require 2)	609MM	N/A	75MM	10MM	N/A
------------------	---	-------	-----	------	------	-----



<b>BSA-S6058</b>	Superior beam / head flat to suit 6' with <u>round holes</u> . 20mm mounting bolt holes @ 152mm centres. (USE BSA-S6081 SPACER BEAM) <b>BSA-S3393</b> MOUNTING BOLT (require 2) <b>BSA-100852</b> NUT (require 2)	916MM	N/A	75MM	10MM	N/A
------------------	---	-------	-----	------	------	-----

OEM REF:  
S6058  
S6054 (8mm THICK)



Beam Bolt & Nut: BSA-100675 Bolt & BSA-100852 Nut

<b>BSA-S2113</b>	Superior beam / head flat to suit 6' with <u>square holes</u> . 20mm mounting bolt holes @ 152mm centres. (USE BSA-S6081 SPACER BEAM) <b>BSA-S3393</b> MOUNTING BOLT (require 2) <b>BSA-100852</b> NUT (require 2)	916MM	N/A	75MM	10MM	N/A
------------------	--	-------	-----	------	------	-----

OEM REF:  
S2113  
S6056



Beam Bolt & Nut: BSA-100675 Bolt & BSA-100852 Nut

<b>BSA-S7058</b>	Superior beam / head flat to suit 7' with <u>round holes</u> . 20mm mounting bolt holes @ 152mm centres. (USE BSA-S7059 SPACER BEAM) <b>BSA-S3393</b> MOUNTING BOLT (require 2) <b>BSA-100852</b> NUT (require 2)	1221MM	N/A	75MM	10MM	N/A
------------------	---	--------	-----	------	------	-----

OEM REF:  
S7058  
S7047



Beam Bolt & Nut: BSA-100675 Bolt & BSA-100852 Nut

<b>BSA-S7060</b>	Superior beam / head flat to suit 7' with <u>square holes</u> . 20mm mounting bolt holes @ 152mm centres. (USE BSA-S7059 SPACER BEAM) <b>BSA-S3393</b> MOUNTING BOLT (require 2) <b>BSA-100852</b> NUT (require 2)	1221MM	N/A	75MM	10MM	N/A
------------------	--	--------	-----	------	------	-----

OEM REF:  
S7060  
S7038



Beam Bolt & Nut: BSA-100675 Bolt & BSA-100852 Nut

SUPERIOR 16MM Thick spacer beams

**BSA-S6081** SUIT 6 FOOT (790mm Long)  
**BSA-S7059** SUIT 7 FOOT (1090mm Long)  
 (20mm bolt holes @ 152mm centres)



Beam Bolt & Nut: BSA-100675 Bolt & BSA-100852 Nut

**PLEASE NOTE: THE FOLLOWING ARE PAGE BEAMS...NOT SUPERIOR. PLEASE CHECK HOLE SIZES AND HOLE CENTRES TO ENSURE CORRECT FITMENT.**

<b>BSA-1496</b>	<b>Page beam</b> / head flat to suit 6' with <u>round holes</u> . 16.5mm mounting bolt holes @ 146mm centres. USE BSA-1383 SPACER BEAM	916MM	N/A	75MM	10MM	N/A
-----------------	--	-------	-----	------	------	-----



<b>BSA-4411</b>	<b>Page beam</b> / head flat to suit 6' with <u>square holes</u> . 16.5mm mounting bolt holes @ 146mm centres. USE BSA-1383 SPACER BEAM	916MM	N/A	75MM	10MM	N/A
-----------------	---	-------	-----	------	------	-----



Part Number	Description	LENGTH	HOLE	WIDTH	THICK	STEP
BSA-5496	<b>Page beam</b> / head flat to suit 7' with <u>round holes</u> . 16.5mm mounting bolt holes @ 146mm centres. (USE BSA-4597 SPACER BEAM)	1221MM	N/A	75MM	10MM	N/A
BSA-5411	<b>Page beam</b> / head flat to suit 7' with <u>square holes</u> . 16.5mm mounting bolt holes @ 146mm centres. (USE BSA-4597 SPACER BEAM)	1221MM	N/A	75MM	10MM	N/A
	<b>PAGE</b> 16MM Thick spacer beams					
	<b>BSA-1383</b> SUIT 6 FOOT (790mm Long) <b>BSA-4597</b> SUIT 7 FOOT (1090mm Long) (16.5mm bolt holes @ 146mm centres)					
BSA-08043	Hex head bolt kit alternative to <b>suit 8mm &amp; 10mm thick blades</b> (1x high tensile bolt, bush & lock nut).					
BSA-08044	Hex head bolt kit alternative to <b>suit 16mm thick blades</b> (1x high tensile bolt, bush & lock nut).					
BSA-08042	Dome head bolt kit to suit 8 & 10mm thick blades (1x Dome head bolt, bush & lock nut). <b>BSA-00178</b> BUSH <b>BSA-S2115M</b> BOLT <b>BSA-PG1113</b> NUT					
BSA-S4027	SUPERIOR CLUTCH DISC 165mm x 64mm x 3.2mm thick					
BSA-S2115K	Dome head bolt kit to suit 16mm thick blades (1x Dome head bolt, bush & lock nut). <b>BSA-00180</b> BUSH <b>BSA-S2115</b> BOLT <b>BSA-PG1113</b> NUT					
BSA-S2114	3/4 X 2 7/8" DOME HEAD BOLT ONLY (USE WITH BSA-00180 BUSH & BSA-PG1113 NUT)					
BSA-S8127	3/4 X 3 1/2" DOME HEAD BOLT (USE WITH BSA-00180 BUSH & BSA-PG1113 NUT)					

## WARATAH / SILVAN

Part Number	Description	LENGTH	HOLE	WIDTH	THICK	STEP
BS-07453	Standard step down blade Left hand cut (Note: Double Cutting Edge style coming soon) <b>BSA-07161B</b> BUSH <b>BSA-07453K</b> BOLT KIT (bolt kit includes 1x bolt & nut)	331MM	38MM	75MM	8MM	47MM
BS-07161	Heavy Duty step down blade DOUBLE EDGE STYLE <b>BSA-07161B</b> BUSH <b>BSA-07453K</b> BOLT KIT (bolt kit includes 1x bolt & nut)	331MM	38MM	100MM	10MM	47MM

# WOODS / TITAN / IRONCRAFT

Part Number	Description	LENGTH	HOLE	WIDTH	THICK	STEP
BS-08138 R/H	Stepped & Fluted blade . BATWING BW180X & 15 Foot Titan (Titan use <b>BSA-09383</b> Bolt & Nut)	571MM	38MM	100MM	13MM	58MM
BS-08139 L/H	BS-08138 is Right Hand cut BS-08139 is Left Hand cut					
BS-09076	Stepped & Fluted blade - Suits 7 Foot Woods deck Left Hand cut (Woods blade Pin NOT available)	714MM	38MM	100MM	13MM	58MM
BS-09075	Stepped & Fluted blade - Suits Titan12 Foot deck - Centre Blade Left Hand cut Use <b>BSA-09383</b> Bolt & Nut	563MM	38MM	75MM	12MM	58MM
BS-09381 LH	Stepped & Fluted blade. Suits 12 Foot Titan deck wings. Use <b>BSA-09383</b> Bolt & Nut - Titan ONLY	405MM	38MM	75MM	12MM	58MM
BS-09382 RH	BS-09381 is Left Hand BS-09282 is Right Hand					

## SLASHER - UNIVERSAL

Part Number	Description	LENGTH	HOLE	WIDTH	THICK	STEP
BS-08959	Universal Blade Flat double edge for both Left & Right hand cut, extra long 350mm cutting edge allows for blade to be cut down. Use BSA-06394B, BSA-00191 or BSA-00192 bushes depending on bolt size.	645MM	38	75MM	10MM	
BS-09251	Universal Blade <b>Step (40mm)</b> double edge for both Left & Right hand cut, extra long 340mm cutting edge allows for blade to be cut down. Use BSA-06394B, BSA-00191 or BSA-00192 bushes depending on bolt size.	645MM	38	75MM	10MM	40MM

COMING SOON

### ASP CASE HARDENED SLASHER BLADE BUSHES - QUICK REFERENCE CHART

Part No	O/D	I/D	Thick	Part No	O/D	I/D	Thick
BSA-01074	45	25	14	BSA-00180	32	20	17
BSA-06394B	38	22	11	BSA-00190	32	22	14
BSA-02003B	38	19.5	14	BSA-01981B	25	19	11
BSA-07161B	37	22	13	BSA-00175	25	16	9
BSA-01073	35	22	14	BSA-07659	22	16	10
BSA-00178	32	19	11	BSA-09385	32	22	11
BSA-00179	32	20	14	BSA-04457B	25	19	9
BSA-00192	38	16	11	BSA-00191	38	19	11

## SLASHER BLADE SIZE CHART

Part #	Brand	Length	Width	Thick	Hole	Step	Profile
BS-09339	MAJOR	185	75	8	25		ANGLED
BS-09343	MAJOR	235	80	10	25		ANGLED
BS-09344	MAJOR	235	80	10	25		ANGLED
BS-07652	LOXTON	238	65	8	23		FLAT
BS-07615	LOXTON	238	70	8	23	22	STEP
BS-07654	LOXTON	238	70	8	23	15	STEP
BS-07653	LOXTON	238	70	8	23	15	STEP
BS-01586	GESSNER	250	65	7	25	22	STEP DOUBLE EDGE
BS-09046 / 47	CHRIS GROW / GASON	250	100	10	32	70	SUCTION LIFT
BS-09050 / 51	CHRIS GROW / GASON	250	100	13	32	70	SUCTION LIFT
BS-04457	BERENDS	262	65	8	26	25	STEP L/H
BS-01582	JARRETT	275	65	7	25	38	SUCTION LIFT L/H
BS-01573	HOWARD	280	75	12	32	0	FLAT TWISTED END L/H
BS-P1938/10	PAGE/ SUPERIOR	305	75	10	32	40	STEP DOUBLE EDGE
BS-P1927	PAGE/ SUPERIOR	305	75	10	32	0	FLAT L/H
BS-01599	PAGE/ SUPERIOR	305	75	16	32	0	FLAT L/H
BS-00797	PAGE/ SUPERIOR	305	75	16	32	40	STEP DOUBLE EDGE
BS-01605	PAGE/ SUPERIOR	305	75	16	32	40	STEP L/H
BS-01601	PAGE/ SUPERIOR	305	75	16	32	40	SUCTION LIFT L/H
BS-00467	DAKEN	330	100	10	38	15	FLAT TWISTED END L/H
BS-07161	WARATAH	331	100	10	38	47	STEP DOUBLE EDGE
BS-07453	WARATAH	331	75	8	38	47	STEP L/H
BS-09271	DIGGA	350	100	13	38	40	STEP DOUBLE EDGE
BS-09044	CHRIS GROW / GASON	350	100	13	32	40	STEP DOUBLE EDGE
BS-01724	HOWARD	355	75	12	32	40	SUCTION L/H
BS-01724R	HOWARD	355	75	12	32	40	SUCTION R/H
BS-08743	HOWARD	355	90	12	32	40	SUCTION L/H
BS-01574	HOWARD	355	75	12	32	40	STEP DOUBLE EDGE
BS-08922 / 23	CHRIS GROW / GASON	357	100	10	32	70	SUCTION LIFT
BS-08226 / 27	CHRIS GROW / GASON	357	100	13	32	60	SUCTION LIFT
BS-01981	BERENDS	368	75	10	26		FLAT L/H
BS-09381 / 82	WOODS / TITAN	405	75	12	38	58	STEP & FLUTED LH & R
BS-09264	HIMAC	415	100	12	38	65	STEP DOUBLE EDGE
BS-01572	HOWARD	432	75	12	32		FLAT TWISTED END L/H
BS-08228 / 29	CHRIS GROW / GASON	450	100	13	32	65	SUCTION LIFT
BS-09045	CHRIS GROW / GASON	450	100	13	32	50	STEP DOUBLE EDGE
BS-09048 / 49	CHRIS GROW / GASON	450	100	10	32	75	SUCTION LIFT
BS-01600	PAGE/ SUPERIOR	460	75	16	32		FLAT L/H
BS-01602	PAGE/ SUPERIOR	460	75	16	32	40	SUCTION LIFT L/H
BS-01602R	PAGE/ SUPERIOR	460	75	16	32	40	SUCTION LIFT R/H
BS-01603	PAGE/ SUPERIOR	460	75	16	32	40	STEP L/H
BS-01604	PAGE/ SUPERIOR	460	75	16	32	40	STEP DOUBLE EDGE
BS-01606	PAGE/ SUPERIOR	460	75	15	32	75	STEP DOUBLE EDGE
BS-S2428	PAGE/ SUPERIOR	460	75	10	32		FLAT L/H
BS-P2028	PAGE/ SUPERIOR	460	75	10	32	40	STEP DOUBLE EDGE
BS-02003	BERENDS	460	100	12	38	25	STEP L/H
BS-01583	JARRETT	490	75	10	32	45	SUCTION LIFT L/H
BS-02000	BERENDS	495	75	10	32	25	STEP DOUBLE EDGE
BS-01585	BERENDS	495	75	10	32		FLAT L/H
BS-1138	MCLEOD	495	100	13	45	45	STEP L/H
BS-00986	MCLEOD	495	75	13	35	40	STEP L/H
BS-09366	HIMAC	495	75	10	32	55	SUCTION LIFT L/H
BS-09281	HOWARD	510	100	12	32	45	SUCTION LIFT L/H
BS-01075	MCLEOD	560	100	13	45	45	STEP L/H
BS-07805	MCLEOD	560	100	13	45	45	STEP & FLUTED L/H
BS-09075	WOODS / TITAN	563	75	12	38	58	STEP & FLUTED L/H
BS-08959	UNIVERSAL	645	75	10	38		FLAT DOUBLE EDGE
BS-09251	UNIVERSAL	645	75	10	38	40	STEP DOUBLE EDGE
BS-08138 / 39	SCHULTE	571	100	13	38	58	STEPPED & FLUTED
BS-08140 / 41	SCHULTE	645	100	13	38	58	STEPPED & FLUTED
BS-09076	FIELDQUIP	714	100	13	38	58	STEPPED & FLUTED

**SLASHER BLADE LENGTH IS MEASURED FROM CENTRE OF HOLE**



## MULCHING HAMMERS & FLAILS



HAMMER



FLAIL



ASP Cast hammers and ground tools are manufactured using a Nickel Chromium Molybdenum Alloy similar to that used in the mining industry for bucket teeth on heavy earth moving equipment. ASP Flails are made in Europe from Boron steel.

ASP offers a huge range of parts delivered Australia wide with same day despatch on all stocked items for orders received prior to 2pm.

**Check out our website:**

**[www.asproducts.com.au](http://www.asproducts.com.au)**



Part Number	Description	Diagram	HOLE	WIDTH	THICK	LENGTH from centre of hole
BS-06943 or <b>BS-06943HF</b> Hard Faced Option	Double edge 'Y' blade. OEM Ref A37094 AMM, ACM & AHM models  BSA-09250 Bush - 55mm long BSA-06943B - 16mm thick Spacers		25.4MM  A= 204 B= 55	60MM	10MM	171MM
CI-1401 or <b>CI-1401HF</b> Hard Faced	Cast hammer flail OEM Ref A-37644 <b>CIA-08472 BOLT</b> <b>BSA-100852 NUT</b> ASM models use CIA-08028 fastener kit New Diamond Hard Faced option		A= 120 B= 40 R= 90 16.5mm Hole			

**AGRIMASTER**

Part Number	Description	Diagram	HOLE	WIDTH	THICK	LENGTH from centre of hole
BS-08490	Double edge blade 'Y' blade  OEM 300 0106		25.5MM  A= 147 B= 62	60MM	8MM	118MM
BS-08491	Flat double edge blade		25.5MM  A= 147	60MM	8MM	118MM
CI-11/20	Cast hammer flail OEM Ref 30011 Em31, Suits FA 175,200 & 2 25 CIA-08330 Bolt & Nut		A= 150 B= 60 R= 90 20.5mm Hole			

**ALPEGO**

Part Number	Description	Diagram	HOLE	WIDTH	THICK	LENGTH from centre of hole
CI-08682	Cast hammer flail OEM Ref MK0A00212. P40061		A= 137 B= 40 R= 95 18.5mm Hole			

**BERENDS (JBI)**

Part Number	Description	Diagram	HOLE	WIDTH	THICK	LENGTH from centre of hole
BS-08001	Double edge blade 'Y' blade Suits pre 2000 mulchers OEM Ref: 1600 use with bolt & nut kit BSA-09081		20.5MM  A= 138 B= 55	50MM	10MM	120MM
BS-08471	Double edge 'L' blade OEM Ref: 1599 use with bolt & nut kit BSA-09081		20.5MM  A= 138 B= 55	50MM	10MM	120MM

**PLEASE CHECK BLADE SIZES BEFORE ORDERING FLAILS & HAMMERS**

Part Number	Description	Diagram	HOLE	WIDTH	THICK	LENGTH from centre of hole
BS-08291	Double edge blade 'Y' blade Suits HIGH body mulchers OEM Ref: 1609 use with bolt & nut kit BSA-09081		20.5MM A= 185 B= 55	50MM	10MM	165MM

**BERTI**

Part Number	Description	Diagram	HOLE	WIDTH	THICK	LENGTH from centre of hole
BS-08835	Double edge 'Y' blade suits TSB High body & King etc OEM Ref 6010F28 <b>BSA-09103</b> Bush 40mm long <b>CIA-08330</b> Bolt & Nut (120mm long) <b>BSA-09327</b> Bush 45mm long <b>CIA-09329</b> Bolt & Nut (90mm long) <b>BSA-09328</b> Spacer 8mm Thick - use with flat blade		28.5MM A= 204 B= 55	60MM	10MM	171MM
BS-09117	Double edge Flat blade option		28.5MM	60MM	8MM	171MM
CI-06/16	Cast hammer flail EM06 suit AF Low body, TA/P & TA/M OEM Ref MP0008, 'P' type hammer <b>CIA-08700 Hex Head Bolt Kit</b> (Check bolt as some use OEM round head)		A= 137 B= 40 R= 95 16.5mm Hole			
CI-08853	Cast hammer flail, 'M' type Mega Rotor. TFH/F & TFH/M, TFB/M, TBM/S OEM Ref: Mp0794, TFB Low Body Use <b>CIA-09322 BOLT KIT</b> Hex Head bolt with 2 points removed, replaces the OEM style square head bolt).		A= 137 B= 84 R= 95 20mm Hole			
CI-08909 or <b>CI-08909HF</b> Hard Faced Option	Cast hammer flail 'A' type suit: TFB, TFB/SB, EKR/S low body, TA/PF, TBM & TA. OEM Ref MP3922 (Use <b>CIA-08992 BOLT KIT</b> Hex Head bolt with 2 points removed, replaces the OEM style square head bolt).		A= 137 B= 52 R= 95 19.5mm Hole			
CI-08496	Cast hammer flail - double edge 'T' type Eco forest, all ECF models with reversible hammers Md1950		A= 71 B= 80 R= 80 30mm Hole			

**BOMFORD**

Part Number	Description	Diagram	HOLE	WIDTH	THICK	LENGTH from centre of hole
CI-FMB003	Cast 'boot' flail. OEM Ref: 0295901  CIA-08031 2mm Collar 0280101 CIA-08029 Bolt Kit 0367525 (Bolt kit includes 1 x bolt, lock nut & washer)		A= 68 B= 12 C= 85 40mm wide cutting edge 16mm x 32mm hole			

Part Number	Description	Diagram		
CI-08773	Double edge 'T' flail. OEM Ref: 46399.01 CI-08776 Flail Kit (kit includes flail, collars & fasteners) CIA-08774 Bush (2 per flail) CIA-08775 Bolt Kit		A= 70 B= 38 R= 105 25.4mm Hole	

**BREVIGLIERI**

Part Number	Description	Diagram				
CI-06/16	Cast hammer flail suit Flash SR, Turbo-T, Master & Super Master OEM Ref 56123		A= 137 B= 40 R= 95 16.5mm Hole			
BS-06943 Or <b>BS-06943HF</b> Hard Faced Option	Double edge 'Y' blade OEM Ref 55002		25.4MM A= 204 B= 55	60MM	10MM	171MM 

**BUFFALO**

Part Number	Description	Diagram	HOLE	WIDTH	THICK	LENGTH from centre of hole
BS-08719	Double edge 'Y' blade (Use with BSA-08097 bush to reduce hole dia to 17mm)		25.4MM	65MM	10MM	140MM A= 170 B= 50 

**CELLI**

Part Number	Description	Diagram	HOLE	WIDTH	THICK	LENGTH from centre of hole
BS-06943 Or <b>BS-06943HF</b> Hard Faced Option	Double edge suit Scorpio etc 'Y' blade <b>BS-279003</b> Straight blade option <b>BSA-06943B</b> 16mm thick Spacer <b>BSA-09269</b> 11.5mm thick spacer (Spacers are 2" OD, please check)  Note: Most models require a 125mm long, flat head bolt, which is only available as OEM)		25.4MM	60MM	10MM	171MM A= 204 B= 55 
BS-09290	Double edge 'Y' blade Suit Gemini & Mizar etc OEM Ref 702611 <b>CIA-08028</b> 90mm long Bolt & Nut		16.5MM	50MM	10MM	103MM A= 123 B= 53 
BS-09291	Straight Double edge blade OEM Ref 702612 (98mm from centre of hole)		16.5MM	50MM	10MM	98MM 

# CELLI Cont.



BoronBlue™



Part Number	Description	Diagram		
CI-1400 <b>CI-1400HF</b> Hard Faced Option	Cast hammer flail suit Vega OEM Ref 704052		A= 120 B= 40 R= 110 16.5mm Hole	
CI-06/16	Cast hammer flail suit Mizar Em06 OEM Ref: 702605		A= 137 B= 40 R= 95 16.5mm Hole	
CI-09279	Cast hammer flail suit Taurus - some, please check sizes. Em04 WITH LARGER HOLE		A= 120 B= 40 R= 110 19.5mm Hole	
<b>COSMAG</b> CI-11/20	Cast hammer flail - some models. Please check sizes. Em31 CIA-08330 Bolt & Nut (120mm long bolt)		A= 150 B= 60 R= 90 20.5mm Hole	

## FAE

Part Number	Description	Diagram		
CI-FMB14	Cast hammer flail Reversible OEM Ref 111120001		A= 70 B= 60 R= 80 31mm Hole	
CI-08996	Cast hammer flail Em32		A= 76 B= 22 R= 95 16.5mm Hole	

## FALC

Part Number	Description	Diagram	HOLE	WIDTH	THICK	LENGTH from centre of hole
BS-06943 Or <b>BS-06943HF</b> Hard Faced Option	Double edge 'Y' blade OEM Ref 43.01.51		25.4MM A= 204 B= 55	60MM	10MM	171MM
BS-279005	Double edge 'L' blade		25.4MM A= 204 B= 47	60MM	10MM	171MM
BS-279003	Double edge <b>Flat blade</b>					
<b>BSA-06943P</b> <b>BSA-06944P</b> <b>BSA-06943B</b> <b>BSA-09269</b>	Flat head Threaded 1" Pin with Nut & Washers Flat head Split Pin style 1" Pin 16mm Thick Spacer Bush (2" OD & 1" ID) 11.5mm Thick Spacer Bush (used with Straight blade)					

# FALC Cont.



BoronBlue™



Part Number	Description	Diagram		
CI-08942 Or <b>CI-08942HF</b>	Hammer Flail alternative for BS-06943 'Y' blades <b>Hard Faced Option</b>		A= 115 B= 50 R= 171 25.5mm Hole	
CI-08999 Or <b>CI-08999HF</b>	Hammer Flail OEM Ref 66 00 00 <b>Hard Faced Option</b>		A= 105 B= 54 R= 98 25.5mm Hole	

# FERRI

Part Number	Description	Diagram	HOLE	WIDTH	THICK	LENGTH from centre of hole
BS-08490	Double edge blade 'Y' blade OEM 0901003 Suits MKD200/230/250/280		25.5MM	60MM	8MM	115MM
BS-08491	<b>Flat double edge blade</b> Suits MKD200/230/250/280		A= 147 B= 62			
CI-08750	Double edge 'T' flail KIT (kit includes flail, bush, 2 x Spacers & fasteners)		A= 64 B= 38 R= 115 25.4mm Hole			

# FORIGO

Part Number	Description	Diagram	HOLE	WIDTH	THICK	LENGTH from centre of hole
BS-09039	Double edge 'Y' blade use BSA-09040 Bush, BSA-09041 End Spacer x 2 & BSA-09042K Bolt & Nut		25.4MM	60MM	10MM	125MM
			A= 153 B= 60			

# GESSNER / LOFTNESS

Part Number	Description	Diagram	HOLE	WIDTH	THICK	LENGTH from centre of hole
<b>BS-09143HF</b>	<b>Hard Faced</b> Double edge 'Y' blade		24MM	60MM	8MM	150MM
BSA-09144	U Bracket		A= 173 B= 50			
BSA-09145	Bush					

# HAYES

Part Number	Description	Diagram		
CI-09384	Cast hammer flail EM37		A= 87 B= 40 R= 100 16.5mm HOLE	

**\*\* PLEASE CHECK BLADE DIMENSIONS \*\***

# HOWARD (KRONOS)



BoronBlue™



Part Number	Description	Diagram	HOLE	WIDTH	THICK	LENGTH from centre of hole
BM-181024	Single edge blade <b>BMA-151002</b> Shackle <b>BSA -09270</b> Spacer		16 x 36MM	40MM	12MM	A= 98 B= 39
BS-06943 Or <b>BS-06943HF</b> Hard Faced Option	Double edge 'Y' blade suit Alce & Kronos etc <b>BSA-06944P</b> Pin & Split pin <b>BSA-06943B</b> 16mm Spacer (2" OD) <b>BSA-09269</b> 11.5mm Spacer		25.4MM	60MM	10MM	171MM A= 204 B= 55
BS-279005	Double edge 'L' blade					A= 204 B= 47
BS-279003	Double edge Flat blade					A= 204
CI-08942 <b>CI-08942HF</b> Hard Faced Option	Hammer Flail alternative for BS-06943 'Y' blades suit Alce etc					A= 115 B= 50 R= 171 25.4mm Hole

## JANKE

**BSA-06944P** Pin to suit 25.4mm hole complete with Spit Pin

Part Number	Description	Diagram	HOLE	WIDTH	THICK	LENGTH from centre of hole
<b>BS-Y90HF</b> Hard Faced	Riveted 'Y' blade assembly use with <b>BSA-Y90CC</b> Bush & Fastener Kit (includes Bush, Bolt, Nut & 2 X washers)		20MM	65MM	10MM	145MM A= 170 B= 80 (total of both together)

## KRONE

Part Number	Description	Diagram	HOLE	WIDTH	THICK	LENGTH from centre of hole
BM-336003	Double edge blade 'Y' blade		14.5MM	40MM	5MM	115MM A= 134 B= 40

## KUHN

Part Number	Description	Diagram	HOLE	WIDTH	THICK	LENGTH from centre of hole
BS-06943 Oem Ref 6060004 <b>BS-06943HF</b> Hard Faced Option	Double edge 'Y' blade. 6060004 <b>BSA-06943P</b> Threaded pin <b>BSA-06943B</b> 16mm Spacer <b>BSA-09269</b> 11.5mm Spacer <b>BSA-06944P</b> Split Pin style Bolt		25.4MM	60MM	10MM	171MM A= 204 B= 55
CI-08942 <b>CI-08942HF</b> Hard Faced Option	Hammer Flail alternative for BS-06943 'Y' blades OEM Ref JX136378					A= 115 B= 50 R= 171 25.4mm Hole

Part Number	Description	Diagram	HOLE	WIDTH	THICK	LENGTH from centre of hole
BS-08009	Double edge 'Y' blade (Comes supplied as 2 x BS-06943 flails & 1 x BSA-08097 bush) <b>Check clearance from centre of mount to drum, requires min 32mm.</b>		17MM	60MM	10MM	171MM
			A= 204 B= 55			

**MASCHIO**

Part Number	Description	Diagram	HOLE	WIDTH	THICK	LENGTH from centre of hole
BS-08303	Double edge 'Y' blade OEM Ref: T40005142 Suits CL, ML & MS models  (Use with BS-09022 Flat blade)		25.5MM	60MM	8MM	190MM
			A= 210 B= 61			
BS-08304	Double edge blade 'Y' blade to suit BA models OEM Ref: T21004040 (Requires 2 of BSA-00192 spacers)		16.5MM	45MM	8MM	120MM
			A= 136 B= 60			
BS-08490	Double edge blade 'Y' blade to suit some models		25.5MM	60MM	8MM	115MM
			A= 147 B= 62			
CI-1400	Cast hammer flail Em04 T24004025 Suits BL & CR models		A= 120 B= 40 R= 110 16.5mm Hole			
<b>CI-1400HF</b> Hard Faced Option						
CI-11/20	Cast hammer flail Em31 OEM Ref M03400410R		A= 150 B= 60 R= 90 20.5mm Hole			
CI-06/16	Cast hammer flail EM06 OEM Ref 21004030 CIA-08028 Bolt & Nut (90mm long from under the head)		A= 137 B= 40 R= 95 16.5mm Hole			

**McCONNEL**

Part Number	Description	Diagram	HOLE	WIDTH	THICK	LENGTH from centre of hole
CI-1387	Double edge 'T' flail. OEM Ref: 73.14.366 <b>CI-1387K</b> Flail Kit suit F10 (Note: will not suit F14 head) (Kit includes Flail, bush & fasteners) <b>CIA-1387BK</b> Fastener kit (includes 1 x bush, bolt & lock nut)					
			A= 60 B= 38 R= 135 25.4mm Hole			
CI-09248	H/Duty Single sided Hammer option suit F10					
BS-09100	Double edge Y blade suit ROBOCUT mowers OEM 4000242 (44 required per set) <b>BSA-09113</b> Bush / Spacer <b>BSA-09114</b> Bolt & Nut		12.5MM	40MM	6MM	90MM
			A= 100 B= 45			

# MDB GREEN CLIMBER



BoronBlue™



Part Number	Description	Diagram	
CI-09062	Cast hammer flail Suits LV600 etc Mulcher		A= 85 B= 40 R= 100 14.5mm Hole

## M.E.A.A.T

Part Number	Description	Diagram	HOLE	WIDTH	THICK	LENGTH from centre of hole
BS-06943	Double edge 'Y' blade Suits TS140, TS160 & TS300		25.4MM	60MM	10MM	171MM
<b>BS-06943HF</b>	<b>Hard Faced Option</b>		A= 204 B= 55			
BS-279005	Double edge 'L' blade					
BS-279003	Double edge Flat blade		A= 204			
CI-08682	Cast hammer flail		A= 137 B= 40 R= 95 18.5mm Hole			

## MOTT

Part Number	Description	Diagram	HOLE	WIDTH	THICK	LENGTH from centre of hole
BM-100759HD	Double edge 'Y' blade BM-100761 Shackle (50mm long from centre of hole, 28mm wide inside) BMA-102670 Pin (11mm x 75mm) BMA-00026 Split pin		13 x 27MM	40MM	5MM	65MM
			A= 82 B= 39			

## MURATORI

Part Number	Description	Diagram	HOLE	WIDTH	THICK	LENGTH from centre of hole
BS-08814	Double edge 'Y' blade OEM Ref: 12007800		20.5MM	40MM	10MM	97MM
			A= 110 B= 46			

## MUTHING

Part Number	Description	Diagram	HOLE	WIDTH	THICK	LENGTH from centre of hole
CI-06/16	Cast hammer flail EM06 OEM Ref MU000306H CIA-08028 Bolt & Nut (90mm long from under the head)		A= 137 B= 40 R= 95 16.5mm Hole			



Part Number	Description	Diagram	HOLE	WIDTH	THICK	LENGTH from centre of hole
BS-06943	Double edge, 'Y' blade Suits BNU, BNG, NK, RM, P. OEM Ref: N2555004		25.4MM	60MM	10MM	171MM
<b>BS-06943HF</b>	<b>Hard Faced Alternative</b>		A = 204 B = 55			
BSA-06943P	Flat head Threaded 1" Pin with Nut & Washers					
BSA-06944P	Flat head Split Pin style 1" Pin					
BSA-06943B	16mm Thick Spacer Bush. 2" OD & 1" ID					
BSA-09269	11.5mm Thick Spacer Bush (used with Straight blade)					
BS-279005	Double edge 'L' blade					
BS-279003	Double edge Flat blade OEM Ref: N1551000		A = 204			
BS-1781000	Double edge 'Y' blade Suits BNE & TB OEM Ref: N1781000		16.5MM	40MM	8MM	110MM
CI-1400	Cast hammer flail Em04 OEM Ref N1891002 Suits TBL, VK, VKE, VKD, VKR, WMU & BNE		A = 120 B = 40 R = 110 16.5mm Hole			
<b>CI-1400HF</b>	<b>Hard Faced Option</b>					
CI-08926	H/Duty Hammer flail alternative to the BS-06943.					
CI-08942	Hammer Flail alternative for BS-06943 'Y' blades OEM Ref N2555002					
<b>CI-08942HF</b>	<b>Hard Faced Option</b>					
CI-09279	Cast hammer flail EM04/19 Some models with 19.5mm hole - check as will not suit models with 20mm bolts		A = 120 B = 40 R = 110 19.5mm Hole			
CI-08999	Hammer Flail BV100PRO, MAZZA66, 001394 Requires longer bolt than BSA-06943P. Bolt OEM Only.		A = 105 B = 54 R = 98 25.5mm Hole			
<b>CI-08999HF</b>	<b>Hard Faced Option</b>					





ASP is introducing a select range of popular Hammers & Flails with either a High Carbon Chrome, fine grit Tungsten or new Diamond coating to the cutting edge, as an option.

Unlike the traditional application of tungsten grit hard facing, that is applied in a weld form, the ASP hard faced option is applied in a thin coating that does not reduce the cutting performance of the flail or hammer.

**LOOK FOR THE 'HF' PART NUMBER OPTION!  
ASP HARD FACED HAMMERS &  
FLAIL BLADES.**

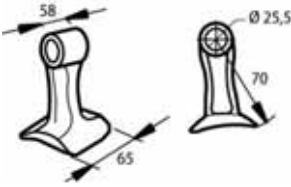





## NOREMAT

Part Number	Description	Diagram	Dimensions	Image
CI-09208	Cast hammer flail Use <b>CIA-08774L</b> Bushes x 2 <b>CIA-09365</b> Bolt & Nut		A= 65 B= 58 R= 70 25.5mm Hole	

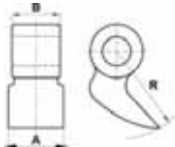

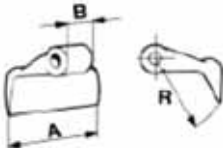
Please check your Flail or Hammer dimensions to ensure correct fitment.

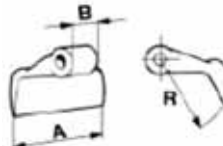
If in doubt, please contact ASP on 07 3881 3464 or email [sales@asproducts.com.au](mailto:sales@asproducts.com.au)

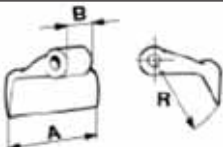

## ORSI & PERUGINI

Part Number	Description	Diagram	Dimensions	Image
CI-08989	Cast hammer flail, single edge W Forrest models OEM Ref 00023109		A = 70 B = 60 R = 80 31mm Hole	
<b>CI-08989HF</b>	<b>Hard Faced Option</b>			
CI-08753	Cast hammer flail <b>CIA-08028</b> Special Bolt set		A= 147 B= 54 R= 97 16.5mm Hole	
CI-09206	Cast hammer flail Comfort, Dynamic & Twice models OEM Ref 00023130		A= 146 B= 54 R= 100 20.5mm Hole	

## SALIBA

Part Number	Description	Diagram	Dimensions	Image
CI-09293	Cast hammer flail Em08 / 20 TLB series etc.		A= 120 B= 40 R= 90 20.5mm Hole	

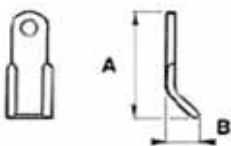
## SAUERBURGER

Part Number	Description	Diagram	HOLE	WIDTH	THICK	LENGTH from centre of hole	Image
<b>BS-09028HF</b>	<b>Hard Faced</b> Double edge 'Y' blade Use <b>BSA-09034</b> Fastener kit (includes Pin, Bush & Roll Pins) or BSA-09103 Bush		29MM	60MM	6MM	180MM	
			A= 210 B= 45				

Part Number	Description	Diagram	HOLE	WIDTH	THICK	LENGTH from centre of hole
BS-08304	Double edge blade 'Y' blade to replace CI-1400  (Requires 2 of BSA-00192 spacers)		16.5MM  A= 136 B= 60	45MM	8MM	120MM
CI-09293	Cast hammer flail Em08/20		A= 120 B= 40 R= 90 20.5mm Hole			
CIA-08028	Suits CI-1401 & CI-1400 Hammers Oversized hex head (27mm) & 5/8" diameter shank, 90mm long from under the head (65mm bare shank) with crush nut.					
CI-1401	Cast hammer flail Em08 OEM Ref: 13002041, 15002041 <b>CIA-08028</b> Special bolt set (OEM Ref: 13002075)		A= 120 B= 40 R= 90 16.5mm Hole			
<b>CI-1401HF</b> Hard Faced Option	<b>New Diamond Hard Faced option</b>					
CI-1400	Cast hammer flail Em04 OEM Ref: 13002001 <b>CIA-08028</b> Special bolt set (OEM Ref: 13002075)		A= 120 B= 40 R= 110 16.5mm Hole			
<b>CI-1400HF</b> Hard Faced Option						
CI-08989	Cast hammer flail, single edge OPT240, Miniforst, Midiforst. DT, Superforst & Forst M		A = 70 B = 60 R = 80 31mm Hole			
<b>CI-08989HF</b> Hard Faced Option						
CI-FMB14	Cast hammer flail Reversible OEM Ref: 11001008		A= 70 B= 60 R= 80 31mm Hole			

**SICMA**

Part Number	Description	Diagram	HOLE	WIDTH	THICK	LENGTH from centre of hole
BS-08814	Double edge 'Y' blade Suits TS, TSL & TVF		20.5MM  A= 110 B= 46	40MM	10MM	97MM
BS-09324	Double edge 'Y' blade Suits TLX model		16.5MM  A= 117 B= 48	40MM	8MM	100MM
BS-08490	Double edge blade 'Y' blade		25.5MM  A= 147 B= 62	60MM	8MM	118MM
BS-08491	Flat double edge blade					

Part Number	Description	Diagram	
CI-11/20	Cast hammer flail Em31		A= 150 B= 60 R= 90 20.5mm Hole

**SIMATECH**

Part Number	Description	Diagram	
CI-09293	Cast hammer flail EM08/20 DHL Range DHL80 & 95		A= 120 B= 40 R= 90 20.5mm Hole

**Please check your Flail or Hammer dimensions prior to ordering to ensure correct fitment. If in doubt, please call 07 3881 3464 or email [sales@asproducts.com.au](mailto:sales@asproducts.com.au)**

**SOVEMA**

Part Number	Description	Diagram	HOLE	WIDTH	THICK	LENGTH from centre of hole
BS-06943	Double edge 'Y' blade		25.4MM	60MM	10MM	171MM
<b>BS-06943HF</b>	<b>Hard Faced Alternative</b>					
BS-279005	Double edge 'L' blade					
BS-279003	Double edge Flat blade					
CI-08817	Single edge flail <b>BSA-08818</b> Shackle					

**TIERRE**

Part Number	Description	Diagram	HOLE	WIDTH	THICK	LENGTH from centre of hole
BS-09021	Double edge 'Y' blade BSA-08880 Bush		25.4MM	60MM	7MM	
BS-09022	Double edge Flat blade		25.4MM	60MM	8MM	

Part Number	Description	Diagram	
CI-08996	Cast hammer flail OEM 16022, 411-480-643 Warlord etc		A= 76 B= 22 R= 95 16.5mm Hole
CI-09249	Gamma Flail style hammer. Cast hammer flail OEM 411-160-105 Can use <b>CI-09249K (flail, bolt, nut &amp; bush)</b> CIA-09275 Bolt & Nut CIA-09276 Bush (16OD x 10ID x 10mm)		A= 55 B= 11 R= 85 16.5mm Hole

**TTQ**

Part Number	Description	Diagram	HOLE	WIDTH	THICK	LENGTH from centre of hole
BS-06943	Double edge 'Y' blade  <b>BSA-06943B</b> 16mm Spacer <b>BSA-09269</b> 11.5mm Spacer <b>BSA-06944P</b> Split Pin style Bolt		25.4MM	60MM	10MM	171MM
<b>BS-06943HF</b> Hard Faced Option						

**ZANON & INO**

Part Number	Description	Diagram	HOLE	WIDTH	THICK	LENGTH from centre of hole
BS-09059	Double edge 'Y' blade		20.5MM	40MM	8MM	105MM
CI-09062	Cast hammer flail <b>14.5mm HOLE</b> 14.5mm Hole Suits Ino Mulcher Em37		A= 119 B= 52			
CI-09384	Cast hammer flail <b>16.5mm HOLE</b> 16.5mm Hole Suits Ino Mulcher Em37		A= 85 B= 40 R= 100 14.5 or 16.5mm HOLE			
CI-1401	Cast hammer flail Em08 CIA-08028 Fastener kit		A= 120 B= 40 R= 90 16.5mm Hole			
<b>CI-1401HF</b> Hard Faced Option New Diamond Hard Faced Option						

**ZENIT & MULCH MASTER**

Part Number	Description	Diagram	
CI-08999	Hammer Flail  <b>BSA-06944P</b> Pin & Split Pin		A= 105 B= 54 R= 98 25.5mm Hole
<b>CI-08999HF</b> Hard Faced Option			

<b>Flails</b>					
	Width	Thickness	Length	Length	Hole
Part No.	W(mm)	T(mm)	(centre)	(overall)	H(mm)
BS-06943	60	10	171	204	25.4
BS-08001	50	10	120	138	20.5
BS-09290	50	10	105	123	16.5
BS-08291	50	10	165	185	20.5
BS-08303	60	8	190	210	25.5
BS-08304	45	8	120	136	16.5
BS-08471 "L"	50	10	120	138	20.5
BS-08490	60	8	115	150	25.5
BS-08491 FLAT	60	8	115	150	25.5
BS-08719	65	10	140	173	25.4
BS-08835	60	10	171	204	28.5
BS-09021	60	7	195	215	25.4
BS-09022	60	8	190	210	25.4
BS-09028	60	6	180	210	29
BS-09039	60	10	125	153	25.4
BS-09059	40	8	100	119	20.5
BS-1781000	40	8	110	128	16.5
BS-279003 FLAT	60	10	171	204	25.4
BS-279005 "L"	60	10	171	204	25.4
BM-336003	40	5	115	134	14.5
BM-100759HD	45	5	65	82	13 x 27
BM-181024	40	12	70	98	16 x 36
BS-505-3000HF	50	5	170	190	17
BS-Y90	65	10	145	170	20



**Y FLAILS**



**L FLAILS**



**FLAT FLAIL**

**Hammer**

	Radius	Cutting	Hole	Knuckle	Ref
Part No.	R (mm)	CF (mm)	H (mm)	KW	OEM
CI-06/16	95	137	16.5	40	EM06
CI-08753	97	147	16.5	54	
CI-08817	70	70	14 X 25	6	
CI-08853	105	140	20	84	
CI-08909	98	140	20	52	
CI-08926	175	88	25.4	51	
CI-08996	95	76	16.5	22	
CI-08999	98	105	25.5	54	
CI-09062	95	85	14.5	40	
CI-1400	110	120	16.5	40	EM04
CI-1401	90	120	16.5	40	EM08
CI-11/20	90	150	20.5	60	EM11
CI-08942	171	115	25.4	50	
CI-FMB14	80	70	31	60	
CI-08496	80	71	31	80	
CI-FMB003	85L, 68H	40W	16 x 32	11	
CI-09293	90	120	20.5	40	
CI-08773	105	60	25.4	38	
CI-1387	135	60	25.4	38	
CI-08682	95	137	18.5	40	
CI-09279	110	120	19.5	40	



**STD HAMMER**



**T HAMMER**



**BOOT HAMMER**

# QUALITY STUMP GRINDER & FIXED MULCHER TEETH, AT AFFORDABLE PRICES!

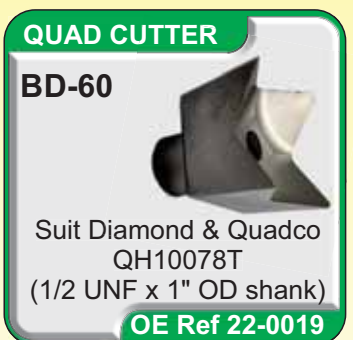

# PUSH MOWER, FINISHING MOWER & TURF HARVESTER BLADES!











**ASP Swing Tip mower blades are measured from the centre of the hole to the end of the blade. We encourage you to measure your old blade prior to ordering.**

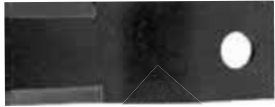
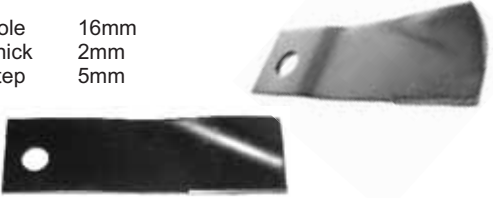









**ASP Mower Blades & Fasteners are not sold as Genuine. Any reference to Original Equipment Manufacturers or Competitors part numbers etc are for ease of identification & reference only.**







# SWING TIP MOWER BLADES

(Blades to suit Push Mowers & Finishing Mowers)

Part Number	Description	
<b>AGRIFARM</b>  <b>BS-30151</b> Replaces OEM 30151	Stepped, double edge swing tip blade  Use with <b>BSA-30444</b> Bolt set (includes 1 x bolt, nut & washer)	Length 110mm from centre of hole Hole 18mm Width 50mm Thick 5mm Step 10mm 
<b>BUSHRANGER</b>  <b>BD-08003 or BD-08279</b>	Stepped & fluted swing tip blade - sold as a pair Right hand cut. Check length.  <b>BD-08003</b> Length 124mm from centre of hole  <b>BD-08279</b> Length 152mm from centre of hole	Hole 16mm Thick 2mm Step 5mm 
<b>COX</b>  <b>BD-08012K</b> Replaces OEM MB150AHD	Stepped & fluted swing tip blade & bolt set - sold as a pair, Right hand cut. Suit 28" & 48" Orion, Scout & Stockman  (Includes 2 x blades & 2 x bolt, nut & washer)	Length 150mm from centre of hole Hole 13mm Width 50mm Thick 3mm Step 10mm 
<b>GREENFIELD</b>  <b>BD-08322K</b> Replaces OEM	Greenfield Anniversary 28", 30" and 32" cut 8HP, 11HP and 12HP Models. Also Fits Evolution 1, 23 & 200, 30", 32" and 34" cut models Also Fits Tractor 11.30 MKII 30" Cut Models  (Includes 2 x blades & 2 x bolt, nut & washer)	Length 185mm from centre of hole Hole 15mm Width 60mm 
<b>HONDA</b>  <b>BD-08003</b>	Stepped & fluted swing tip blade - sold as a pair Right hand cut. Suit 196, 197 & 215  <b>BD-08003BK</b> Bolt set (sold as a pair with D washer) <b>BD-08563</b> Bolt set (sold as a pair without D washer) <b>BD-08206</b> Wave washer (sold each)	Length 124mm from centre of hole Hole 16mm Width 44mm Thick 2mm Step 5mm 
<b>BD-08279</b>	Stepped & fluted swing tip blade - sold as a pair Right hand cut. <b>HIGH LIFT</b> Suit 216 & 217  <b>BD-08003BK</b> Bolt set (sold as a pair with D washer) <b>BD-08563</b> Bolt set (sold as a pair without D washer) <b>BD-08206</b> Wave washer (sold each)	Length 152mm from centre of hole Hole 16mm Width 50mm Thick 2mm Step 5mm 
<b>BD-08280</b>	Stepped & fluted swing tip blade - sold as a pair Right hand cut. <b>LOW LIFT</b> Suit 216 & 217  <b>BD-08003BK</b> Bolt set (sold as a pair with D washer) <b>BD-08563</b> Bolt set (sold as a pair without D washer) <b>BD-08206</b> Wave washer (sold each)	Length 152mm from centre of hole Hole 16mm Width 50mm Thick 2mm Step 5mm 
<b>BD-08003BK</b>	<b>BD-08003BK</b> Bolt set WITH D washers (sold as a pair)	
<b>BD-08563</b>	<b>BD-08563</b> Bolt set without D washer (sold as a pair)	
<b>AF-1332</b> OEM Ref: 17210-ZIV-003	Replacement air filter to fit GXV160H2 engines as fitted to HRU196, HRU216 etc - Complete with rubber seal on base and foam outer filter.  Dimensions: 7 1/2" x 2-1/2" wide x 2" high	

Part Number	Description	
<b>HONDA CONT</b> <b>ASP-701</b> OEM Ref: 42710-VA3-K00	Standard plastic wheel / rubber tread 7 3/4" diameter to suit 1/2" axle. Complete with cap.	
<b>ASP-702</b> OEM Ref: 42810-VJ9-000	Self propelled rear drive plastic wheel / rubber tread. 7 3/4" diameter. Complete with cap.	
<b>ASP-801</b> OEM Ref: 44710-VK0-C80 44710-VL9-B40	New type Honda front & rear wheel 8" with bearing suit 1/2" axle. suits HRU 196 /197K1 & M1 2010 onwards front & rear & front wheels on the 216k2 , M1 & M2 2010 onwards. Check OEM part number <b>Tri Spoke style</b>	
<b>ASP-802</b> OEM Ref: 42810-VJ9-B80	Self propelled rear drive plastic wheel suit new style HRU216 <b>Tri Spoke style</b>	
<b>HOWARD</b> <b>BR-78241</b> Replaces OEM 78241	Stepped & fluted swing tip blade - sold as each Left hand cut. Suit Series 1 Stealth, Procut & Rolla <b>BMA-08065</b> Bolt set (sold each) <b>BR-78241K</b> Blade kit (includes 12 blades & fasteners)	Length 102mm from centre of hole Hole 13mm Width 50mm Thick 3mm Step 8mm 
<b>BR-08754</b> (10 pack Blades) <b>BRA-08755</b> (10 pack Bolts) OEM Ref: TX16084UK10, TX32205K10	<b>ALTERNATIVE</b> for OEM Trimax Lazer blades & bolts. (Will not suit the Condor). Stepped & fluted swing tip blade - sold as a KIT Left hand cut. Suit <b>Series 2</b> Stealth, Procut & Pegasus. (Blade Kit includes 10 blades) <b>MUST USE BRA-08755 BOLT KIT</b> (Bolt Kit includes 10 x bolts & lock nuts)	Length 100mm from centre of hole Hole 20.5mm Width 50mm Thick 4mm Step 8mm 
<b>JARRETT</b> <b>BM-08921</b> Replaces OEM 43751	Stepped & fluted swing tip blade - sold each Left hand cut. <b>BSA-43752</b> Bolt set (sold each) (Bolt set includes 1 x bolt, nut & washer)	Length 100mm from centre of hole Hole 20.5mm Width 50mm Thick 4mm Step 8mm 
<b>K-LINE</b> <b>BS-08905 LH</b> <b>BS-08906 RH</b>	Stepped & fluted swing tip blade - sold each <b>BS-08905 Left Hand Blade</b> <b>BS-08906 Right Hand Blade</b> <b>BSA-43752</b> Bolt set (sold each)	Length 135mm from centre of hole Hole 20.5mm Width 65mm Thick 4mm Step 20mm 
<b>MASSPORT</b> <b>BD-09156K</b> Oem part no. 529594 , 6352 007 1000, 780658	18" deck blade and bolt kit for masport & morrison mowers: Right Hand cut fits cushion, quickcut & quadcut blade systems, rear catcher. Pair Blades & Fasteners	Length 97mm from centre of hole Hole 13mm Width 44mm 
<b>ROVER</b> <b>BD-08005K</b> Replaces OEM 1118	Flat & fluted swing tip blade kit Right hand cut. Suits 18" rear catcher. <b>Sold as a pair</b> (2 blades, bolts, washers & nuts)	Length 94mm from centre of hole Hole 13mm Width 38mm 

Part Number	Description	
<p><b>SALIBA</b>  <b>BS-08579 L/H</b>  <b>BS-08580 R/H</b></p>	<p>Stepped &amp; fluted swing tip blade - sold each            BS-08579 Left hand cut.            BS-08580 Right hand cut  <b>BSA-43752</b> Bolt set (sold each)  <b>BR-08423</b> Kit (includes 8x BS-08579,            8x BS-08580 &amp; 16x BSA-43752)</p>	<p>Length 140mm from centre of hole            Hole 20.5mm            Width 65mm            Thick 4mm            Step 20mm</p> 
<p><b>SAMMUT</b>  <b>BM-08577 L/H</b>  <b>BM-08578 R/H</b></p>	<p>Stepped &amp; fluted swing tip blade - sold each            BM-08577 Left hand cut.            BM-08578 Right Hand cut  <b>BSA-08036</b> Bolt set (sold each)  <b>BR-08422</b> Kit (includes 8x BM-08577, 8x            BM-08578 &amp; 16x BSA-08036)</p>	<p>Length 120mm from centre of hole            Hole 18.5mm            Width 65mm            Thick 4mm            Step 15mm</p> 
<p><b>SUPERIOR</b>  <b>BR-03693</b>            Replaces OEM            S3693</p>	<p>Stepped &amp; fluted swing tip blade - sold each            Left hand cut.  <b>BRA-08088</b> Bolt set (sold each)</p>	<p>Length 197mm from centre of hole            Hole 20.5mm            Width 65mm            Thick 5mm            Step 18mm</p> 
<p><b>BR-08689</b></p>	<p>Stepped &amp; fluted swing tip blade - sold each            Right hand cut.  <b>BRA-08088</b> Bolt set (sold each)</p>	<p>Length 197mm from centre of hole            Hole 20.5mm            Width 65mm            Thick 5mm            Step 18mm</p> 
<p><b>BR-09218</b></p>	<p>Stepped swing tip blade - sold each            Double Edge, Left &amp; Right hand cut  <b>BRA-08088</b> Bolt set (sold each)</p>	<p>Length 197mm from centre of hole            Hole 20.5mm            Width 65mm            Thick 5mm            Step 18mm</p> 
<p><b>BR-08766 LH</b>  <b>BR-09219 RH</b></p>	<p><b>Left hand cut - MULCH</b>  <b>BRA-08088</b> Bolt set (sold each)</p> <p>Stepped &amp; fluted swing tip blade - sold each  <b>Right hand cut - MULCH</b>  <b>BRA-08088</b> Bolt set (sold each)</p>	<p>Length 197mm from centre of hole            Hole 20.5mm            Width 75mm            Thick 5mm            Step 18mm</p> 
<p><b>TORO</b>  <b>BR-09297</b>            Replaces OEM            116-6358-03</p>	<p><b>30" Deck</b>            TimeMaster 20199 , 20200 , 2014 30" cut            TurfMaster Walk Behind Mowers            Flat Mulch Blade RH cut            Requires 2 per set</p>	<p>Length 389mm            Centre Hole 16mm (2 x Outer Holes 7.5mm)            Width 64mm            Thick 4mm            Step 11mm</p> 
<p><b>TRIMAX</b>  <b>BR-08754</b>            (10 pack Blades)  <b>BRA-08755</b> (10 pack)            OEM Ref: 411-160-842,            &amp; 411-322-050</p>	<p><b>ALTERNATIVE</b> for OEM Lazer blades &amp; bolts.            Stepped &amp; fluted swing tip blade - sold as a KIT            Left hand cut. Suit <b>Series 2, 3 &amp; 4</b> on Stealth, Procut,            Pegasus, Merlin &amp; Snake etc            (BR-08754 Blade Kit includes 10 blades)  <b>MUST USE BRA-08755 BOLT KIT</b>            (BRA-08755 Bolt Kit includes 10 x bolts &amp; lock nuts)</p>	<p>Length 100mm from centre of hole            Hole 20.5mm            Width 50mm            Thick 4mm            Step 8mm</p> 
<p><b>UNIVERSAL</b>  <b>BM-V100RH</b>  <b>&amp; BM-V100LH</b></p>	<p>Stepped &amp; fluted swing tip blade - sold each            Right hand cut.  <b>BMA-08062</b> Bolt set (sold each)            (Bolt set includes 1 x bolt, nut &amp; washer)  <b>BM-V100RHK</b> Bulk kit of 60 blades &amp; fasteners  <b>BM-V100LH LEFT HAND</b> - Sold as each blade</p>	<p>Length 120mm from centre of hole            Hole 13mm            Width 65mm            Thick 3mm            Step 6mm</p> 
<p><b>VICTA</b>  <b>BD-08006K</b>            Replaces OEM            Ca09306</p>	<p>Flat &amp; fluted swing tip blades &amp; bolts - sold as a            pair of blades &amp; bolts, washers &amp; nuts            Right hand cut. Suits 18" rear catcher.</p>	<p>Length 98mm from centre of hole            Hole 15mm            Width 44mm            Thick 2mm            Step N/A</p> 

# TURF HARVESTER BLADES

6mm THICK SIDE PLATES WITH EXTRA DEPTH FOR LONGER CUTTING LIFE



PART NUMBER	SIZE	APPLICATION
<b>BTC16-8</b>	<b>16 INCH</b>	<b>VAN VUUREN, BROUWER &amp; POYNTZ</b>
<i>BTC16-8-131</i>	16 INCH	AS ABOVE - WITH 4 X 131mm FINGERS
<b>BTC16-8F</b>	<b>16 INCH</b>	<b>RYAN, KESMAC &amp; SIMPSON</b>
<i>BTC16-8F-131</i>	16 INCH	AS ABOVE - WITH 4 X 131mm FINGERS
<i>BTC16-8F-207</i>	16 INCH	AS ABOVE - WITH 4 X 207mm FINGERS
<b>BTC18-8-1</b>	<b>18 INCH</b>	<b>VAN VUUREN, BROUWER &amp; POYNTZ</b>
<i>BTC18-8-1-131</i>	18 INCH	AS ABOVE - WITH 4 X 131mm FINGERS
<b>BTC18-8F</b>	<b>18 INCH</b>	<b>RYAN, KESMAC &amp; SIMPSON</b>
<i>BTC18-8F-131</i>	18 INCH	AS ABOVE - WITH 4 X 131mm FINGERS
<b>BTC23-8F</b>	<b>23 INCH</b>	<b>RYAN, KESMAC, BROUWER, TREBRO &amp; FIREFLY ETC</b>
<i>BTC23-8F-131</i>	23 INCH	AS ABOVE - WITH 5 X 131mm FINGERS
<i>BTC23-8F-180</i>	23 INCH	AS ABOVE - WITH 5 X 180mm FINGERS
<i>BTC23-8F-280</i>	23 INCH	AS ABOVE - WITH 5 X 280mm FINGERS
<i>BTC23-8F-300</i>	23 INCH	AS ABOVE - WITH 5 X 300mm FINGERS
<b>BTC24-8F</b>	<b>24 INCH</b>	<b>RYAN, KESMAC, BROUWER, TREBRO &amp; FIREFLY ETC</b>
<i>BTC24-8F-180</i>	24 INCH	AS ABOVE - WITH 5 X 180mm FINGERS
<i>BTC24-8F-207</i>	24 INCH	AS ABOVE - WITH 5 X 207mm FINGERS
<i>BTC24-8F-230</i>	24 INCH	AS ABOVE - WITH 5 X 230mm FINGERS

**ASP** Turf cutters are the only blades available in Australia made entirely from European Boron steel. Both side plates and bottom blades are through hardened for maximum hardness and operational life. Our blades are used by Original Equipment Sod Harvester manufacturers in Europe.

The blade cutting edge is sharpened with a double bevel to ensure the cutting edge is maintained even in difficult stony areas.

## BORON STEEL TURF CUTTERS

# RIDE ON MOWER BLADES



## How to Measure your Blade

Length: A. Measure the blade diagonally from cutting tip to cutting tip.

Width: B. Measure the width at the widest part of the blade.

C. Measure the center hole.

D. Measure the center to center distance between the outer holes.

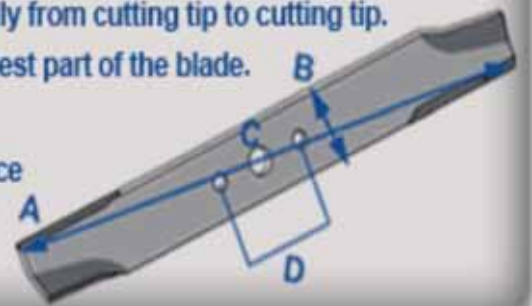

ASP ride on mower blades are manufactured in Europe from high quality Boron steel to ensure wear capabilities that at the very least meet OEM standards but generally far exceed them.

ASP mower blades are typically 50Rc hardness, high carbon alternatives are typically 40Rc. The extra hardness in ASP blades means superior wear resistance and because Boron in the steel prevents the blade becoming brittle in heat treatment, it ensures you enjoy at least 30% longer life from ASP blades.

ASP blades are without a doubt the best performing blade available for all Australian conditions.

<h1>ARIENS</h1>		
Part Number	Description	
<b>BR-09302</b> Replaces OEM 21546235	<b>54" Deck - 3 Blade Deck (GATOR G3 95-605)</b> Stepped & Fluted Mulch Blade RH cut. Star shape hole. 936040, 936054, 936055, 936059, 936078 ETC <i>(Genuine Oregon G3 Gator, not ASP Boron)</i>	Length 469mm Hole STAR Width 64mm Thick 5mm Step 12mm 
<b>BR-09304</b> Replaces OEM 00273000, 04919100	<b>48" Deck - 3 Blade Deck (GATOR G6 396-716)</b> Flat & Fluted Mulch Blade RH cut. Select models inc 715052, 715053, 715054, 715055, 788034, 788035, 788057, 788058, 792022, 792034, 888308, 915035 (1640), 915037 (1844), 915039 (2048), 915041 (2252), 915051 (1640), 988320 (HE1748FLPCE) <i>(Genuine Oregon G6 Gator, not ASP Boron)</i>	Length 413mm Hole 16mm Width 75mm Thick 6mm Step N/A 
<h1>BAD BOY</h1>		
Part Number	Description	
<b>BR-08207</b> Replaces OEM 038-7220-00 038-7230-00	<b>72" Deck - 3 Blade Deck</b> Flat & Fluted Blade RH cut. Select models inc Outlaw & Lightning 7200, Z series & ZTR	Length 621mm Hole 16mm Width 65mm Thick 8mm Step N/A 
<b>BR-08726</b> Replaces OEM 038-7220-00 038-7230-00	<b>72" Deck - 3 Blade Deck</b> Stepped & Fluted Mulch Blade RH cut. Select models inc Outlaw & Lightning 7200, Z series & ZTR	Length 621mm Hole 16mm Width 65mm Thick 7mm Step 5mm  <b>BoronBlue™ Mulcher Blades</b>
<b>BR-D18037</b> Replaces OEM 038-3000-00	<b>36" Deck - 2 Blade Deck</b> <b>52" Deck - 3 Blade Deck</b> Flat & Fluted RH cut. Select models. Check sizes.	Length 457mm Hole 16mm Width 65mm Thick 5mm Step N/A 
<b>BR-08891</b> Replaces OEM 038-3000-00	<b>36" Deck - 2 Blade Deck</b> <b>52" Deck - 3 Blade Deck</b> Flat & Fluted MULCH blade RH cut. Select models. Check sizes.	Length 457mm Hole 16mm Width 65mm Thick 6mm Step N/A 



**Don't forget your  
Trimmer Line!**

See page 82 for  
details



<h1>BIG DOG</h1>			
Part Number	Description		
<b>BR-08952</b> Replaces OEM 600901, 793794,793794X	<b>60" Deck</b> R series (26HP model 931535) & ZTR Series Flat & Fluted. RH cut. Requires 3 blades per set	Length 520mm Hole 16mm Width 65mm Thick 6mm Step N/A	
<b>BR-08910</b> Replaces OEM 794214, 794230	<b>60" Deck</b> R series (26HP model 931535) & ZTR Series Flat, Mulch. RH cut. Requires 3 blades per set	Length 520mm Hole 16mm Width 65mm Thick 6mm Step N/A	
<b>BR-08950</b> Replaces OEM 601124	<b>54" Deck</b> R series 24HP model 931519 ZTR Flat & Fluted RH cut  Requires 3 blades per set	Length 470mm Hole 16mm Width 65mm Thick 6mm Step N/A	
<b>BR-09131</b> Replaces OEM	<b>54" Deck</b> R series 24HP model 931519 ZTR Flat & Mulch RH cut  Requires 3 blades per set	Length 470mm Hole 16mm Width 65mm Thick 6mm Step N/A	
<b>BR-08407</b> Replaces OEM 601123	<b>48" Deck.</b> R series 22 HP models 931493 & ZTR select models Flat & High Lift Flute. Right Hand cut.  Requires 3 blades per set	Length 418mm Hole 16mm Width 65mm Thick 6mm Step N/A	
<b>BR-08895</b> Replaces OEM 601123	<b>48" Deck.</b> R series 22 HP models 931493 & ZTR select models Flat & Mulch. Right Hand cut.  Requires 3 blades per set	Length 418mm Hole 16mm Width 65mm Thick 6mm Step N/A	
<h1>BOB-CAT</h1>			
Part Number	Description		
<b>BR-D18036</b> Replaces OEM 112111-03 112243-03 42180B	<b>61" Deck.</b> CRZ 61, FastCat Pro, Predator Pro, Procat SE, XRZ & ZTR Stepped & Fluted RH cut Requires 3 blades per set	Length 533mm Hole 16mm Width 65mm Thick 6mm Step 6mm	
<b>BR-09304</b> Replaces OEM 112111-01	<b>48" Deck - 3 Blade Deck - GATOR G6 396-716</b> Flat & Fluted Mulch Blade RH cut. Select models inc CRZ48 (942600, 942600AU, XRZ48 (942610), FastCat Pro SE (942298H with serial # 2274 and below, ZTR models <i>(Blade is OEM Oregon Gator, not ASP Boron)</i>	Length 413mm Hole 16mm Width 75mm Thick 6mm Step N/A	

# BOB-CAT Continued

<p><b>BR-D18036</b> Replaces OEM 112111-03, 112243-03</p>	<p><b>42" Deck</b>, Stepped &amp; Fluted RH cut Requires 2 blades per set Select models inc CRZ42 (942603, 942603EU, FastCat RZ 42 Select models &amp; ZTR models Check dimensions.</p>	<p>Length 533mm Hole 16mm Width 65mm Thick 6mm Step 6mm</p> 
<p><b>BR-08891</b> Replaces OEM 32022, 32022a</p>	<p><b>36" Deck - 2 Blade Deck</b>  Flat &amp; Fluted MULCH blade RH cut. Select models. Check sizes.</p>	<p>Length 457mm Hole 16mm Width 65mm Thick 6mm Step N/A</p> 
<h2>CRAFTSMAN</h2>		
<p><b>Part Number</b></p>	<p><b>Description</b></p>	
<p><b>BR-08224</b> Replaces OEM 134149, 138971</p>	<p><b>42" Deck</b>. Flat &amp; Fluted. Right Hand cut.  Requires 2 blades per set</p>	<p>Length 535mm Hole 5PT Star Width 57mm Thick 4mm Step N/A</p> 
<h2>CUB CADET</h2>		
<p><b>Part Number</b></p>	<p><b>Description</b></p>	
<p><b>BR-09315</b> Replaces OEM 742-04415, X &amp; XG 942-04415</p>	<p><b>60" Deck</b>. Stepped Blade. G3 Gator 96-300. Right Hand cut. Requires 3 blades per set 17ASDALD099 (Z8600), 17BSDALD099 (Z8200), GT1500, LT1000, SLT1500, ZHD-L60 17ANDALD897 <i>(Blade is Oregon Gator, not ASP Boron)</i></p>	<p>Length 533mm Hole 19mm Width 75mm Thick 5mm Step 13mm</p> 
<p><b>BR-09314</b> Replaces OEM 742-04416, X &amp; 942-04416</p>	<p><b>54" Deck</b>. Stepped Blade. G3 Gator 96-351. Right Hand cut. Requires 3 blades per set  SL, SLT, LT1000, GT1500, RZT &amp; Z-FORCE  <i>(Blade is Oregon Gator, not ASP Boron)</i></p>	<p>Length 483mm Hole 19mm Width 75mm Thick 5mm Step 15mm</p> 
<p><b>BR-08963</b> Replaces OEM 742-04053, 742-04123</p>	<p><b>50" Deck</b>. Stepped &amp; Fluted. Right Hand cut. Requires 3 blades per set  RZT models etc  <i>(Replaces the OEM 6 point star hole)</i></p>	<p>Length 452mm Hole 6PT Star Width 65mm Thick 5mm Step 24mm</p> 
<p><b>BR-09313</b> Replaces OEM 742-04417, X &amp; 942-04417, 02005017-X, 1005336P, 2005017</p>	<p><b>48" Deck</b>. Stepped Blade. G6 Gator 392-139. Right Hand cut. Requires 3 blades per set  17ASDALB099 (Z8200), 17BSDALB099 (Z8200) PRO Z100 <i>(Blade is Oregon Gator, not ASP Boron)</i></p>	<p>Length 432mm Hole 19mm Width 75mm Thick 6mm Step 11mm</p> 
<p><b>BR-115227A</b> Replaces OEM 942-0616, 742-0616</p>	<p><b>42" Deck</b>. Flat &amp; Fluted. Mulch &amp; Discharge Right Hand cut. Requires 2 blades per set ZTR &amp; RZT42  <i>(Replaces the OEM 6 point star hole)</i></p>	<p>Length 539mm Hole 6PT Star Width 70mm Thick 4mm Step N/A</p> 



Part Number	Description	 
<b>BR-09300</b> Replaces OEM 13926, 510417901, 532134149, 532138971, 539118038, 539119843, 539119852	<b>61" Deck.</b> Flat Blade. G5 Gator 596-900. Right Hand cut. Requires 3 blades per set To suit Selected models. Refer OEM Reference. <i>(Blade is Oregon Gator, not ASP Boron)</i>	Length 533mm Hole 5PT Star Width 75mm Thick 4mm Step N/A 
<b>BR-08210</b> Replaces OEM 18931, 9383, 12441	<b>Fits Toro 60" Deck</b> Flat & Fluted R/H cut Requires 3 per set. Suits 8025, ZTR560 (1993), ZTR5601 (94-96), ZTR6601 (95-96) ZTR models	Length 520mm Hole 16mm Width 63mm Thick 6mm Step N/A 
<b>BR-08910</b> Replaces OEM 18931, 9383, 12441	<b>Fits Toro 60" Deck</b> Flat & Fluted R/H cut Requires 3 per set. Suits 8025, ZTR560 (1993), ZTR5601 (94-96), ZTR6601 (95-96) ZTR models	Length 520mm Hole 16mm Width 64mm Thick 6mm Step N/A  <b>BoronBlue™            Mulcher Blades</b>
<b>BR-09303</b> Replaces OEM 13867, 13918, 13943, 13944, 13945, 13947, 17279, 17280, 17281, 539119836, 539119862	<b>44" Deck.</b> Flat Blade. G3 Gator 496-399. Right Hand cut. Requires 3 blades per set To suit RAM & Selected models. Refer OEM Reference. <i>(Blade is Oregon Gator, not ASP Boron)</i>	Length 379mm Hole 17.5mm Width 63mm Thick 5mm Step N/A 
<b>BR-08956</b> Replaces OEM 575296401	<b>48" Deck - RAM ZTR</b> Flat & Fluted RH cut. Requires 3 blades	Length 412mm Hole 5PT Star Width 65mm Thick 5mm Step N/A 
<b>BR-08224</b> Replaces OEM 532134149	<b>42" Deck - SPD ZTR</b> Flat & Fluted RH cut. Requires 2 blades	Length 535mm Hole 5PT Star Width 57mm Thick 5mm Step N/A 
<b>BR-08957</b> Replaces OEM 539112078	<b>42" Deck - 3 Blade Deck</b> Flat & Fluted RH cut. Requires 3 blades	Length 372mm Hole 5PT Star Width 65mm Thick 5mm Step N/A 

## ECOTEQ (MEAN GREEN) MOWER BLADES REFER PAGE 71



**Need Trimmer Heads?**  
 ASP stocks Speed Feed style &  
 Commercial Grade  
 Italian 'F One' Rapid Feed heads.  
 Refer page 83 for details.







# FERRIS



Part Number	Description	
<b>BR-08207</b> Replaces OEM 22476	<b>72" Deck.</b> Flat & Fluted. Right Hand cut. Requires 3 blades Selected ZTR models  <i>(Check blade length)</i>	Length 621mm Hole 16mm Width 65mm Thick 8mm Step N/A  
<b>BR-08217</b> Replaces OEM 155000	<b>72" Deck.</b> Stepped & Fluted. Right Hand cut.  Requires 3 blades  <i>(Check blade length)</i>	Length 630mm Hole 16mm Width 65mm Thick 6mm Step 6mm  
<b>BR-D18036</b> Replaces OEM 1520842, A48384, 502842, 5101755	<b>61" Deck.</b> Stepped & Fluted. Right Hand cut. Is32002, IS2000Z, IS2100Z, IS2500Z etc Requires 3 blades per set	Length 533mm Hole 16mm Width 65mm Thick 6mm Step 6mm  
<b>BR-09300</b> Replaces OEM 1520842, A48384, 502842	<b>61" Deck.</b> Flat Blade. G5 Gator 596-900. Right Hand cut. Requires 3 blades per set To suit Selected models. Refer OEM Reference.  <i>(Blade is Oregon Gator, not ASP Boron)</i>	Length 533mm Hole 5PT Star Width 75mm Thick 4mm Step N/A  
<b>BR-D18037</b> Replaces OEM 15212275, 1521227 A48185, 51017565, 1756152	<b>52" (3 blades) &amp; 36" (2 blades) Deck.</b> Flat & Fluted. 5652852, Is2100, Is2500, F125, F150 Right Hand cut.	Length 457mm Hole 16mm Width 65mm Thick 5mm Step N/A  
<b>BR-08891</b> Replaces OEM 15212275, 1521227 A48185	<b>52" (3 blades) &amp; 36" (2 blades) Deck.</b> Flat Mulcher.  Right Hand cut.	Length 457mm Hole 16mm Width 65mm Thick 6mm Step N/A   <p style="text-align: right;"><b>BoronBlue™ Mulcher Blades</b></p>
<b>BR-09304</b> Replaces OEM 20843, 5020843, 5101986, 5103303	<b>48" Deck - 3 Blade Deck (GATOR G6 396-716)</b> Flat & Fluted Mulch Blade RH cut. Select models, F50XT, IS1500ZKAV21 & ZTR  <i>(Genuine Oregon G6 Gator, not ASP Boron)</i>	Length 413mm Hole 16mm Width 75mm Thick 6mm Step N/A  
<b>BR-08407</b>	<b>48" Deck.</b> Flat & High Lift Flute. Right Hand cut. (some models only - check length) Requires 3 blades per set (Note: will not suit 400S models as they require 20mm hole)	Length 418mm Hole 16mm Width 65mm Thick 6mm Step N/A  
<b>BR-08895</b>	<b>48" Deck.</b> Flat Mulcher. Right Hand cut. (some models only - check length) Requires 3 blades per set	Length 418mm Hole 16mm Width 65mm Thick 6mm Step N/A   <p style="text-align: right;"><b>BoronBlue™ Mulcher Blades</b></p>







# GRASSHOPPER



Part Number	Description	
<b>BR-06271</b> Replaces OEM 320250	<b>72" Deck</b> Stepped & Fluted RH cut Requires 3 blades per set  Replaces OEM 320250	Length 639mm Hole 13mm Width 65mm Thick 6mm Step 7mm  
<b>BR-562390</b> Replaces OEM 320236	<b>52" Deck</b> Flat & Fluted RH cut  Requires 3 blades per set	Length 456mm Hole 13mm Width 65mm Thick 5mm Step N/A  
<h1>GRAVELY</h1>		
<b>BR-08207</b> Replaces OEM 047685, 08983851	<b>72" Deck</b> Hi-Flow Blade Flat. RH cut.  Requires 3 blades per set	Length 621mm Hole 16mm Width 65mm Thick 8mm Step N/A  
<b>BR-08726</b> Replaces OEM 047685, 08983851, 09838	<b>72" Deck</b> Mulcher Blade. Stepped. RH cut.  Requires 3 blades per set	Length 621mm Hole 16mm Width 65mm Thick 6mm Step 6mm  
<b>BR-08952</b> Replaces OEM 046999, 08898900, 08979651	<b>60" Deck</b> 200-300 Series Flat & Fluted. RH cut.  Requires 3 blades per set	Length 520mm Hole 16mm Width 65mm Thick 6mm Step N/A  
<b>BR-08910</b> Replaces OEM 046999, 08898900, 08979651	<b>60" Deck</b> 200-300 Series etc Mulcher Blade Flat. RH cut.  Requires 3 blades per set	Length 520mm Hole 16mm Width 65mm Thick 6mm Step N/A   <b>BoronBlue™ Mulcher Blades</b>
<b>BR-D18037</b> Replaces OEM	<b>52" Deck</b> Flat & Fluted RH cut  Requires 3 blades per set	Length 457mm Hole 16mm Width 65mm Thick 5mm Step N/A  
<b>BR-08891</b> Replaces OEM	<b>52" Deck</b> Mulcher Blade Flat. RH cut. Requires 3 blades per set	Length 457mm Hole 16mm Width 65mm Thick 6mm Step N/A   <b>BoronBlue™ Mulcher Blades</b>



# GREAT DANE









Part Number	Description	
<b>BR-D18036</b> Replaces OEM GDU10232, D18036	<b>61" Deck</b> Stepped & Fluted RH cut Requires 3 blades per set  <i>Use blade Bolt BRA-08246</i>	Length 533mm Hole 16mm Width 65mm Thick 6mm Step 6mm  
<b>BR-D18037</b> Replaces OEM GDU10231, D18037	<b>52" and 36" Deck</b> Flat & Fluted RH cut  Requires 3 blades per set for 52" and 2 blades per set for 36".	Length 457mm Hole 16mm Width 65mm Thick 5mm Step N/A  
<b>BR-08891</b> Replaces OEM GDU10231, D18037	<b>52" and 36" Deck</b> Mulcher Blade RH cut Requires 3 blades per set for 52" and 2 blades per set for 36".  <i>Use blade Bolt BRA-08246</i>	Length 457mm Hole 16mm Width 64mm Thick 6mm Step N/A  
<b>BR-08407</b> Replaces OEM GDU10230, D18086	<b>48" and 32" Deck</b> Flat & Fluted RH cut Requires 3 blades per set for 48" and 2 blades per set for 32".  <i>Use blade Bolt BRA-08246</i>	Length 418mm Hole 16mm Width 64mm Thick 6mm Step 6mm  
<b>BR-08895</b> Replaces OEM GDU10230, D18086	<b>48" and 32" Deck</b> Razorback Mulcher Blade RH cut Requires 3 blades per set for 48" and 2 blades per set for 32".  <i>Use blade Bolt BRA-08246</i>	Length 418mm Hole 16mm Width 64mm Thick 6mm Step N/A  
<h1>HUSQVARNA</h1>		
<b>BR-09300</b> Replaces OEM 138498, 138791, 138971, 510417901, 521981601, 531307224, 532131323, 53213897, 539113312	<b>61" Deck. Flat Blade. G5 Gator 596-900.</b> Right Hand cut. Requires 3 blades per set Ez6124, MZ61, MZ460X, Z560, MZ6128 577240401, 586230101, 917127843, 917131323, 917138489MS, 917532138498 <i>(Blade is Oregon Gator, not ASP Boron)</i>	Length 533mm Hole 5Pt Star Width 75mm Thick 4mm Step N/A  
<b>BR-D18036</b> Replaces OEM 53910293, 539101733	<b>61" Deck</b> Stepped & Fluted RH cut ZTH6123KAA, WHF5218ETS Requires 3 blades per set	Length 533mm Hole 16mm Width 65mm Thick 6mm Step 6mm  
<b>BR-D18037</b> Replaces OEM 5391057-12, 5391003-41, AYP100341	<b>52" Deck &amp; 36" Deck</b> Flat & Fluted RH cut Requires 3 blades per set for 52" and 2 blades per set for 36"	Length 457mm Hole 16mm Width 65mm Thick 5mm Step N/A  

<b>BR-08891</b> Replaces OEM 5391057-12, AYP100341	<b>52" Deck &amp; 36" Deck</b> Mulcher Blade RH cut, Requires 3 blades per set for 52" and 2 blades per set for 36"	Length 457mm Hole 16mm Width 65mm Thick 6mm Step N/A	
<b>BR-09306</b> Replaces OEM 574870801, 575240701	<b>52" Deck</b> Flat Blade. G5 Gator 596-900. Right Hand cut. Requires 3 blades per set To suit Selected models. Refer OEM Reference.  <i>(Blade is Oregon Gator, not ASP Boron)</i>	Length 451mm Hole 5PT Star Width 75mm Thick 4mm Step N/A	
<b>BR-08956</b> Replaces OEM 539 11 34-25	<b>48" Fabricated Decks</b> YTH2648TDF, ZTR & Ez4824 MODELS, TS348 Flat & Fluted RH cut Requires 3 blades per set.	Length 413mm Hole 5PT Star Width 64mm Thick 5mm Step N/A	
<b>BR-08407</b> Replaces OEM 539 10 60-40, AYP100340	<b>48" Decks</b> IZ4821 & ZTR models Flat & Fluted RH cut  Requires 3 blades per set.	Length 418mm Hole 16mm Width 64mm Thick 6mm Step N/A	
<b>BR-08895</b> Replaces OEM 539 10 60-40, AYP100340	<b>48" Decks</b> IZ4821 & ZTR models Flat Mulch RH cut  Requires 3 blades per set.	Length 418mm Hole 16mm Width 64mm Thick 6mm Step N/A	
<b>BR-09319</b> Replaces OEM 173920, 180054, 917173920, 917532173920, 917532180054, 954633774	<b>48" Decks Flat Blade. G3 Gator 96-615</b> Requires 3 blades per set. 512258301, 532173920, 532180054, 539107519, 575938201, 575938301, 577146201 etc <i>(Blade is Oregon Gator, not ASP Boron)</i>	Length 424mm Hole 5 PT Star Width 64mm Thick 5mm Step N/A	

**OEM Reference numbers are used for identification only, we also encourage you to check blade dimensions prior to ordering. ASP blades are not sold as genuine.**

<b>BR-09301</b> Replaces OEM 532405380, 594892801	<b>46" Deck. Step Blade Oregon 195-070.</b> Right Hand cut. Requires 2 blades per set To suit Selected models. Refer OEM Reference. 405380, 532405380, 575937901, 777405380, 917532405380, 917777405380 <i>(Blade is Oregon, not ASP Boron)</i>	Length 581mm Hole 5PT Star Width 70mm Thick 4mm Step 8mm	
<b>BR-09300</b> Replaces OEM 539113312	<b>42" Deck. Flat Blade. G5 Gator 596-900.</b> Right Hand cut. Requires 2 blades per set To suit Selected models. Refer OEM Reference.  <i>(Blade is Oregon Gator, not ASP Boron)</i>	Length 533mm Hole 5PT Star Width 75mm Thick 4mm Step N/A	
<b>BR-08224</b> Replaces OEM 532138498, AYP138498, 127843, 532138971 AYP138971	Fits Husqvarna <b>42" Decks</b> Lt125, Lt140, Lt150, LTH1342, XTH1542XP Models, LTH1742, LTH1842 & LTH2142D etc Flat & Fluted RH cut  Requires 2 blades per set.	Length 535mm Hole 5PT Star Width 57mm Thick 4mm Step N/A	

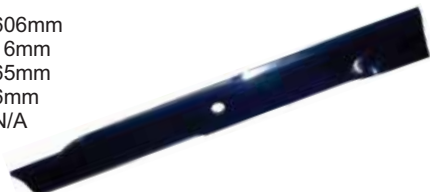
<b>BR-09305</b> Replaces OEM 539112078, 573953001, 577146101	<b>42" Decks</b> Flat Blade. G3 Gator 95-088 Requires 3 blades per set. Ez4216, Ez4217, Ez4220 & Fabricated decks Flat & Fluted RH cut <i>(Blade is Oregon Gator, not ASP Boron)</i>	Length 371mm Hole 5PT Star Width 64mm Thick 5mm Step N/A 
<b>BR-08957</b> Replaces OEM 5391120-78	Fits Husqvarna <b>42" Decks</b> Ez4216, Ez4217, Ez4220 & Fabricated decks Flat & Fluted RH cut Requires 3 blades per set.	Length 371mm Hole 5PT Star Width 65mm Thick 5mm Step N/A 
<b>BR-09318</b> Replaces OEM 513897001, 531307220, 531307221, 532127842, 532131322, 532134148	Fits <b>38" Deck</b> Flat Blade. G3 Gator 95-601 Li19538 etc 581116302, 777193957, 917127842, 917131322, 917134148MS, 917134148X, 917139774MS, 917532134148, 917532138497, 917532138970, 917532139774, 917532193957 <i>(Blade is Oregon Gator, not ASP Boron)</i>	Length 489mm Hole 5PT Star Width 64mm Thick 5mm Step N/A 
<h1>HUSTLER</h1> 		
<b>Part Number</b>  <b>BR-09243K</b> <b>5 BLADE KIT</b>	<b>Description</b>  Fits <b>SUPER 104. Blade Kit includes:</b> 1 x BR-08954 RH cut wing blade 1 x BR-08955 LH cut wing blade 2 x BR-08952 RH centre deck blades 1 x BR-08953 LH centre deck blades	
<b>BR-08207</b> Replaces OEM 798702, 9820361	Fits <b>72" Deck</b> Flat & High Fluted RH cut, Side Discharge Xr7 series, Super Z HD & 3700 series Requires 3 blades per set  Use BRA-08948 Bolt & BRA-08949 Washer	Length 621mm Hole 16mm Width 65mm Thick 8mm Step N/A 
<b>BR-08726</b> Replaces OEM 798702, 9820361	Fits <b>72" Deck</b> Stepped Mulcher RH cut Xr7 series & 3700 series Requires 3 blades per set  Use BRA-08948 Bolt & BRA-08949 Washer	Length 621mm Hole 16mm Width 65mm Thick 7mm Step 5mm 
<b>BR-08954</b> Replaces OEM 796839, 794867, 784728	Fits <b>REAR DISCHARGE 72" Deck</b> Flat & Fluted <b>RIGHT HAND</b> cut <i>(Requires 2 x BR-08954 RIGHT HAND &amp;  1x BR-08955 LEFT HAND)</i>  Use BRA-08948 Bolt & BRA-08949 Washer	Length 606mm Hole 16mm Width 65mm Thick 6mm Step N/A 
<b>BR-08955</b> Replaces OEM 796508, 601929	Fits <b>REAR DISCHARGE 72" Deck</b> Flat & Fluted <b>LEFT HAND</b> cut <i>(Requires 2 x BR-08954 RIGHT HAND &amp;  1x BR-08955 LEFT HAND)</i>  Use BRA-08949 Washer	Length 606mm Hole 16mm Width 65mm Thick 6mm Step N/A 

**ALL BLADES ARE SOLD AS SINGLES  
(INDIVIDUALLY) PLEASE ORDER THE  
QUANTITY REQUIRED TO MAKE UP A SET.**

<b>BR-08952</b> Replaces OEM 602771, 794685, 793794	Fits <b>60" Deck</b> Side Discharge Flat & Fluted Blade RH cut Suits VX4, X-One, Fastrak, Sport etc Requires 3 blades per set  Use BRA-08948 Bolt & BRA-08949 Washer	Length 520mm Hole 16mm Width 65mm Thick 6mm Step N/A	
<b>BR-08910</b> Replaces OEM 794230, 794214	Fits <b>60" Deck</b> Flat Mulcher Blade RH cut Suits VX4, X-One, Fastrak, Sport etc Requires 3 blades per set  Use BRA-08948 Bolt & BRA-08949 Washer	Length 520mm Hole 16mm Width 64mm Thick 6mm Step N/A	
<b>BR-08953</b> Replaces OEM 795633, 601928	Fits <b>60" REAR DISCHARGE</b> Deck Flat & Fluted Blade <b>LEFT HAND</b> cut  <i>Requires 2 x (BR-08952) RIGHT HAND &amp; 1 x (BR-08953) LEFT HAND</i>	Length 520mm Hole 16mm Width 65mm Thick 6mm Step N/A	
<b>BR-08950</b> Replaces OEM 797696, 797704, 601012	Fits <b>54" Deck</b> Side Discharge Flat & Fluted RH cut Xr7 series, Fastrak, Sport, X-One VX4 etc  Requires 3 blades per set	Length 470mm Hole 16mm Width 65mm Thick 6mm Step N/A	
<b>BR-09131</b> Replaces OEM	Fits <b>54" Deck</b> Side Discharge - MULCH Flat & Fluted RH cut Xr7 series, Fastrak, Sport, X-One VX4 etc Requires 3 blades per set	Length 470mm Hole 16mm Width 65mm Thick 6mm Step N/A	
<b>BR-08951</b> Replaces OEM 601013	Fits <b>54" REAR DISCHARGE</b> Deck Flat & Fluted Blade <b>LEFT HAND</b> cut  Requires 2 x (BR-08950) RIGHT HAND & 1 x (BR-08951) LEFT HAND	Length 470mm Hole 16mm Width 65mm Thick 6mm Step N/A	
<b>BR-D18037</b> Replaces OEM 783753, 785436	Fits <b>52" Deck</b> Flat & Fluted RH cut Fastrak, Mini Z etc  Requires 3 blades per set	Length 457mm Hole 16mm Width 65mm Thick 5mm Step N/A	
<b>BR-08891</b> Replaces OEM 783753, 785436	Fits <b>52" Deck</b> Flat Mulcher RH cut Fastrak, Mini Z etc  Requires 3 blades per set	Length 457mm Hole 16mm Width 65mm Thick 6mm Step N/A	
<b>BR-08407</b> Replaces OEM 601123, 797757	Fits <b>48" Deck</b> Flat & High Fluted Blade RH cut Suits Vx4, X-One, Fastrak, Super Duty etc  Requires 3 blades per set	Length 418mm Hole 16mm Width 64mm Thick 6mm Step N/A	
<b>BR-08895</b> Replaces OEM 796623, 796631	Fits <b>48" Deck</b> Flat Mulcher Blade RH cut Suits Vx4, X-One, Fastrak, Super Duty etc  Requires 3 blades per set	Length 418mm Hole 16mm Width 64mm Thick 6mm Step N/A	

<b>BR-09307</b> Replaces OEM 785728, 787739	Fits <b>44" Deck</b> G3 Gator 96-302 Flat Mulcher Blade R/H cut Suits Various, check OEM Ref number  Requires 3 blades <i>(Blade is Oregon Gator, not ASP Boron)</i>	Length 397mm Hole 16mm Width 70mm Thick 5mm Step N/A  
<b>BR-08952</b> Replaces OEM	Fits <b>42" Deck</b> Flat & Fluted Blade R/H cut Suits Fastrak, Raptor & Zeon series  Requires 2 blades	Length 520mm Hole 16mm Width 65mm Thick 6mm Step N/A  
<b>BR-08910</b> Replaces OEM	Fits <b>42" Deck</b> Flat Mulcher Blade R/H cut Suits Fastrak, Raptor & Zeon series  Requires 2 blades	Length 520mm Hole 16mm Width 65mm Thick 6mm Step N/A   <b>BoronBlue™  Mulcher Blades</b>
<b>Part Number</b>	<b>ISEKI</b>  <b>Description</b>	
<b>BR-07162A</b> Replaces OEM 3496107M91, 3495550M4	Fits <b>72" Deck</b> Stepped & Fluted RH cut Sf300 Series etc  Requires 3 blades per set Use BRA-83665A washer & BRA-100293 Nut	Length 628mm Hole 20mm Width 60mm Thick 7mm Step 15mm  
<b>BR-0525A</b> Replaces OEM 797696, 797704, 601012	Fits <b>60" Deck</b> Stepped & Fluted RH cut Sf300 Series etc  Requires 3 blades per set Use BRA-83665A washer & BRA-100293 Nut	Length 527mm Hole 20mm Width 60mm Thick 7mm Step 15mm  
<b>BB-08040</b> Replaces OEM 865520201301	BELT to suit <b>72" Deck</b>  Suits SF300 & Sf340  (Will not suit other models)	

**ALL BLADES ARE SOLD AS SINGLES (INDIVIDUALLY)  
PLEASE ORDER THE QUANTITY REQUIRED TO MAKE UP  
A SET.**

OEM Reference numbers are used for identification only, we also encourage you to check blade dimensions prior to ordering.

ASP blades are not sold as genuine.



# JOHN DEERE



Part Number	Description	
<b>BR-07473</b> Replaces OEM M119565, M80783, Am102401, M141786	Fits John Deere <b>72" Deck</b> 1145 series, 850, 855, 870, 950, 970, 1050, 1070, 4115, 4200, 4210, 4300, 4400, 4500, 4600, 4610, 4700, 4710, F925, F930, F932, F935. Flat & Fluted Blade. Requires 3 per set Use Bolt BRA-100195, Washer BRA-83665.	Length 634mm Hole 23mm Width 65mm Thick 8mm Step N/A 
<b>BR-07473S</b> Replaces OEM M141669, M83363, EPC201693	Fits John Deere <b>72" Deck Standard Lift Blade</b> 1445, 1545, 1565, 1585, 777, 797, 4200, 4500 series, 997 Diesel & 1580 Terrain, Stepped and Fluted. Requires 3 per set. Use Bolt BRA-100195SH, Use Tension Washer BRA-83665.	Length 632mm Hole 23mm Width 60mm Thick 8mm Step 10mm 
<b>BR-08772</b> Replaces OEM TCU15882, M141669, M143749	Fits John Deere <b>72" Deck</b> 1435, 1565, 1585, Z830A, 997, 1445, Z950A, Z950M, Z950R, Z960M, Z970R, Z970A, Z960A Stepped, <b>High Lift Blade</b> Requires 3 Per Set. Bolt BRA-100195SH, Washer BRA-83665.	Length 632mm Hole 23mm Width 75mm Thick 7mm Step 12mm 
<b>BR-08466</b> Replaces OEM M142514	Fits John Deere <b>72" Decks</b> Stepped Mulcher Blade Requires 3 Per Set.  Use Bolt BRA-100195SH, Use Tension Washer BRA-83665.	Length 634mm Hole 23mm Width 65mm Thick 8mm Step 7mm 
<b>BR-09019</b> Replaces OEM M141786, M141669, M83363, EPC201693	Mulcher style to Fit side discharge <b>72" decks</b> on 1445, 1545, 1565, 1585, 777, 797, 4200, 4500 series, 997 Diesel & Terrain Requires 3 per set. Step & Fluted. Use Bolt BRA-100195SH, Use Tension Washer BRA-83665.	Length 632mm Hole 23mm Width 65mm Thick 7mm Step 10mm  <p><b>BoronBlue™ Mulcher Blades</b></p>
<b>BR-08560</b> Replaces OEM TCU51118, M144297	Fits <b>62" Deck</b> , 7 Iron Deck & 1600 Wide area mower, 1400-1500 Series & Terrain. 1600 series 3 Turbo. Stepped and Fluted Blade. Use Bolt BRA-100195SH, Use Tension Washer BRA-83665.	Length 555mm Hole 23mm Width 65mm Thick 8mm Step 8mm 
<b>BR-06253</b> Replaces OEM M141785, M87622	Fit's John Deere <b>60" Deck</b> F1145 Flat & Fluted Blade  Requires 3 blades per Set	Length 521mm Hole 23mm Width 65mm Thick 8mm Step N/A 
<b>BR-128485</b> Replaces OEM TCU15881, M128485, M133381	Fits <b>60" Deck</b> - Stepped & Fluted Z950A, M665, F620, F680, F687, 737, 757, 777, 797 Diesel, 1420, 1435, 1445, 1545, X700, 1565, 4210, 4310, 4410, Z830A, Z720A, Z960A, Z830, 840, 850, Z860, Z970R, Z997, Z994R, Z915E, Z920 - Z960M, 1026R, ZTRAC & Terrain - Requires 3 blades per set	Length 531mm Hole 23mm Width 65mm Thick 8mm Step 10mm  <p>Bolt BRA-100195SH, Washer BRA-83665.</p>
<b>BR-128485M</b> Replaces OEM TCU15881, M128485, M133381	Fits <b>60" Deck</b> - MULCH Stepped & Fluted Z950A, M665, F620, F680, F687, 737, 757, 777, 797 Diesel, 1420, 1435, 1445, 1545, X700, 1565, 4210, 4310, 4410, Z830A, Z720A, Z960A, Z830, 840, 850, Z860, Z970R, Z997, Z994R, Z915E, Z920 - Z960M, ZTRAC & Terrain - Requires 3 blades per set	Length 531mm Hole 23mm Width 65mm Thick 8mm Step 10mm  <p><b>BoronBlue™ Mulcher Blades</b></p>





<b>BR-08470</b> Replaces OEM M136195, TCU30316, M144652, TCU30317 M164016	<b>54" Deck</b> Stepped & Fluted Blade X700, 737, Z820A, Z830A, Z920, Z710A, Z915B, Z925, Z915E, Z920M, Z930M, Z930R, Z720E, X758 Requires 3 Per Set. BRA-100195SH Bolt & BRA-83665 Washer	Length 483mm Hole 23mm Width 65mm Thick 5mm Step 7mm 
<b>BR-09310</b> Replaces OEM M136195, TCU30316, M144652, TCU30317 M164016	<b>54" Deck. G6 Gator 396-769</b> Stepped & Fluted Blade X700, 737, Z820A, Z830A, Z920, Z710A, Z915B, Z925, X758 Requires 3 Per Set. <i>(Blade is Oregon Gator, not ASP Boron)</i>	Length 483mm Hole 23mm Width 75mm Thick 6mm Step 10mm 
<b>BR-08962</b> Replaces OEM M143520, M145516	<b>54" Deck</b> Z425, X320, X380, Z540, X748, 737, Z820A, EZ Trac, GX & X570, X580, X584, X590 Z & LX series 1025, Z445, X540 Stepped & Fluted Blade. Requires 3 Per Set.	Length 480mm Hole 20mm Width 65mm Thick 6mm Step 10mm 
<b>BR-09309</b> Replaces OEM M143520, M145516, M152726, UC22010	<b>54" Deck. G6 Gator 396-769</b> Z425, X320, X380, Z540, X748, 737, Z820A, EZ Trac, GX & X570, X580, X584, X590 Z & LX series 1025, Z445, X540 Requires 3 Per Set. Stepped & Fluted Blade <i>(Blade is Oregon Gator, not ASP Boron)</i>	Length 481mm Hole 20mm Width 75mm Thick 6mm Step 12mm 

**ALL BLADES ARE SOLD AS SINGLES (INDIVIDUALLY)  
PLEASE ORDER THE QUANTITY REQUIRED TO MAKE  
UP A SET.**

<b>BR-127500</b> Replaces OEM M145476, M127500	<b>48" &amp; 48C &amp; ACCEL Decks</b> Lx277, LX279, LX280, LX289, GT245, GT235E, GX325, GX335, X355, X380, 465, 475, 485, 495, 575, LT180, X700, 700, 720, 724, 728, Z425, Z445, X324, X320, X590 Requires 3 blades per set	Length 430mm Hole 21mm Width 65mm Thick 5mm Step 7mm 
<b>BR-08701</b> Replaces OEM, M136185, TCU21475, TCU14939, M136194, TCU30315	<b>48" Deck</b> F620, F680, Z510A, Z645, Z710A, Z810A, Z820A, Z910A, Z915E, Z920M, 17H17B & Zg18 Walk Behinds & Z720E Stepped Hi Lift Blade Right Hand cut. Requires 3 blades per set BRA-100195SH Bolt, BRA-83665 Washer	Length 430mm Hole 23mm Width 65mm Thick 6mm Step 17mm 
<b>BR-09298</b> Am137757, AM137758, AM141035, AM141036, GX21784, GX21785, Gx21786, Gy20852	<b>48" Deck. G3 Gator 92-616</b> Stepped & Fluted. Requires 3 blades per set. 145 155C LA130 LA140 LA145 LA155 LA165 Lawn Tractors, D140 D150 D155 D160 E140 E150 E160 E170 100 Series Tractors X140 X165 X166 Select Series Tractors Z245 Z255 Z355E Ztrak <i>(Blade is Oregon Gator, not ASP Boron)</i>	Length 432mm Hole 7 Pt Star Width 63mm Thick 5mm Step 6mm 
<b>BR-08756</b> Replaces OEM Gx22151, Gy20850 Am137329	<b>42" Deck "Starlock blade"</b> D110, Z225, LA100, LA105, LA110, LA115, LA120, LA125, LA135, X110, X120, X300, D110, D130, S240 Sport, E100, E120, E130, Mulch & Discharge Blade Right Hand cut Requires 2 blades per set.	Length 543mm Hole 7 Pt Star Width 65mm Thick 4.5mm Step N/A 
<b>BR-20249</b> Replaces OEM Gx20249, GX20433	<b>42" Deck</b> Sabre, L100, L108, L110, L111, Mulch Blade Right Hand cut Flat & Fluted  Requires 2 blades per set	Length 545mm (11mm outer holes @ 95mm) Hole 17mm Width 65mm Thick 5mm Step N/A 

Part Number

**JOHN DEERE** Continued

<p><b>BR-09183</b> Replaces OEM M170639</p>	<p><b>42" ACCEL Deck</b> X300, X354, X370, Z335 &amp; Z345 Mulch &amp; Discharge Blade Right Hand cut Requires 2 blades per set.</p>	<p>Length 543mm Hole 20mm Width 65mm Thick 4.5mm Step N/A</p> 
<p><b>BR-330397</b> Replaces OEM M83459, AM100991</p>	<p><b>38" Deck</b> High Lift Lt150, STX38, F525 Stepped &amp; Fluted Blade Right Hand cut  Requires 2 blades per set</p>	<p>Length 494mm Hole 18mm Width 75mm Thick 5mm Step 5mm</p> 
<p><b>BR-330290</b> Replaces OEM M82408, M84472, AM100946</p>	<p><b>38" Deck</b> Low Lift LX170, LX180, LT150, LX255, LX288, LX176, LX172, LX188, X300 LX Stepped &amp; Fluted Blade Right Hand cut Requires 2 blades per set.</p>	<p>Length 494mm Hole 18mm Width 65mm Thick 5mm Step 5mm</p> 
<p><b>BR-09308</b> Replaces OEM Am104652, M112974, M112991, M118958, M744449, M82408, M84472</p>	<p><b>38" Deck. G6 Gator 396-709</b> Stepped &amp; Mulch Blade LX170, LX180, LT150, LX255, LX288, LX176, LX172, Lx188 Requires 2 Per Set. <i>(Blade is Oregon Gator, not ASP Boron)</i></p>	<p>Length 495mm Hole 18mm Width 75mm Thick 6mm Step 10mm</p> 
<p><b>BB-08040</b> Replaces OEM M112414, B144</p>	<p>72" John Deere Side Discharge Deck Belt F1145 Model (will not suit later models)</p>	

**Don't forget your Trimmer Line, Edger Blades & Litter Tools!**













Refer page 81 onwards for details.













# KUBOTA



Part Number	Description	
<b>BR-08826</b> Replaces OEM K5677-34340, 70000-25002, 76553-34330, 76550-34350	Fits Kubota <b>72" Deck</b> , High Flow Deck, Stepped & High Fluted, Right hand cut RCK72-28Z(P), RCK72-27B, 30B, RC72-38, RC72-F30, RCK72P-331Z, RCK72P-F36, ZD28, ZD29, 2560, 3060, 3560, F3690, ZD331 Requires 3 blades per set	Length 622mm Hole 29mm Width 75mm Thick 7mm Step 15mm  Use <b>BRA-K6845 Bolt &amp; BRA-K6846 Washer</b>
<b>BR-07462</b> Replaces OEM K5677-34340,70000-25002, 76553-34330, 76550-34350, 76539-34372, K5698-34340	Fits Kubota <b>72" Deck</b> - Standard blade Stepped & Fluted, Right hand cut, RCK72RP-1200Z, RCK72-28Z(P), RCK72-27B, 30B, RC72-38, RC72-F30, RCK72P-331Z, RCK72P-F36, ZD28, ZD29, 2560, 3060, 3560, F3690, ZD331. Requires 3 blades per set	Length 622mm Hole 29mm Width 65mm Thick 7mm Step 14mm  Use <b>BRA-K6845 Bolt &amp; BRA-K6846 Washer</b>
<b>BR-08703</b> Replaces OEM K5677-34340,70000-25002, 76553-34330, 76550-34350, 76539-34372, K5677-9234	Fits Kubota <b>72" Deck</b> Stepped Mulching Blade for all models with 29mm Holes Stepped & Fluted Blade RH cut Requires 3 blades per set	Length 622mm Hole 29mm Width 65mm Thick 7mm Step 14mm  Use <b>BRA-K6845 Bolt &amp; BRA-K6846 Washer</b> 
<b>BR-07129</b> Replaces OEM 76550-34330	Fits Kubota <b>72" Deck</b> Stepped & Fluted, Right hand cut RCK72-25, RC72-28, RC72-29, 29A, RC72-36, 36A, RC-72F20, F24, RC72R-F36B, F2400, 3560. Requires 3 blades per set.	Length 620mm Hole 23mm Width 60mm Thick 7mm Step 12mm 
<b>BR-09085</b> Replaces OEM K5975-3436	Fits Kubota <b>72" Deck</b> ZD1200 series deck, ZD1221, RCK72P-1200Z Hi Lift blade Requires 3 blades per set Use <b>BRA-K6845 Bolt &amp; BRA-09118 Washer</b>	Length 622mm Hole <b>34mm</b> Width 75mm Thick 7mm Step 15mm 
<b>BR-09077</b> Replaces OEM K5975-3436	Fits Kubota <b>72" Deck</b> ZD1200 series deck ZD1221, RCK72P-1200Z Standard blade Requires 3 blades per set Use <b>BRA-K6845 Bolt &amp; BRA-09118 Washer</b>	Length 622mm Hole <b>34mm</b> Width 65mm Thick 7mm Step 14mm 
<b>BR-09079</b> Replaces OEM	Fits Kubota <b>72" Deck</b> ZD1200 series deck ZD1221, RCK72P-1200Z Mulch blade Requires 3 blades per set Use <b>BRA-K6845 Bolt &amp; BRA-09118 Washer</b>	Length 622mm Hole <b>34mm</b> Width 65mm Thick 7mm Step 14mm  
<b>BR-06677</b> Replaces OEM K5651-34340, 76539-34330, 70000-25001, K5647-34330, 76539-34372, 76550-34350, K5645-34340, K5651-34330	Fits Kubota <b>60" Decks</b> ZD21, ZD28, ZD331, ZG & D 326 & 327, ZG331, ZG326P, RCK60-28Z, RCK60-29B, RCK60-30B, RCK60-F36, RCK60P-21Z, RCK60P-327Z, RCK60-F36, RC60-21B, RC60-24B, RC60-71B, RC60-F19, RC60-FZ21,F3690 RCK60-24B, RCK60-27B. Requires 3 Blades	Length 520mm Hole 29mm Width 65mm Thick 7mm Step 14mm  Use <b>BRA-K6845 Bolt &amp; BRA-K6846 Washer</b>
<b>BR-09020</b> Replaces OEM K5651-34340, 76539-34330, 70000-25001, K5647-34330, 76539-34372, 76550-34350	Mulch blade alternative to BR-06677 <b>60" Decks</b> ZD21, ZD28, ZD331, ZG/ZD326 & 327, ZG331, ZG326P, RCK60-28Z, RCK60-29B, RCK60-30B, RCK60-F30, RCK60P-21Z, RCK60P-327Z, RCK60-F36, RC60-21B, RC60-24B, RC60-71B, RC60-F19, RC60-FZ21,F3690 RCK60-24B Requires 3 Blades	Length 520mm Hole 29mm Width 65mm Thick 7mm Step 14mm   Use <b>BRA-K6845 Bolt &amp; BRA-K6846 Washer</b>

<p><b>BR-09386</b> Replaces OEM K5651-34340, 76539-34330 70000-25001, K5647-34330 76539-34372, 76550-34350, K5645-34340, K5651-34330</p>	<p>Fits Kubota <b>60" Decks HIGH LIFT</b> ZD21, ZD28, ZD331, Zg326 &amp; 327, ZG331, ZG326P, RCK60-28Z, RCK60-29B, RCK60-30B, RCK60-F30, RCK60P-21Z, RCK60P-327Z, RCK60-F36, RC60-21B, RC60-24B, RC60-71B, RC60-F19, RC60-FZ21, F3690 RCK60-24B, RCK60-27B. Requires 3 Blades</p>	<p>Length 520mm Hole 29mm Width 65mm Thick 6mm Step 10mm</p>  <p><b>Use BRA-K6845 Bolt &amp; BRA-K6846 Washer</b></p>
<p><b>BR-09078</b> Replaces OEM K5955-34360</p>	<p>Fits Kubota <b>60" Deck</b> ZD1200 Decks</p> <p>Requires 3 Blades</p>	<p>Length 520mm Hole 34mm Width 65mm Thick 7mm Step 14mm</p> 
<p><b>BR-01588</b> Replaces OEM 70722-34330, 70000-25006,</p>	<p>Fits Kubota, <b>60" Deck</b> RC60-71H, RC60-72A, 72H, 82H, 20. Flat Blade Right Hand cut</p> <p>Requires 3 blades per set.</p>	<p>Length 517mm Hole 18mm Width 50mm Thick 6mm Step N/A</p> 
<p><b>BR-06020</b> Replaces OEM 76543-99050, 70000- 25008, 70722-34350 K5371-99040, K5371-34330</p>	<p>Fits Kubota <b>60" Deck</b> Stepped &amp; Fluted, F2100, B7510, BX2660, F2400, BX22, BX1830, G2160, G2460G, RC60-92H, 20, F20, F24, Bx24, Bx25, Bx2380, Bx2350, Bx2360. Bx2380, BX24D, BX25 Right Hand cut Requires 3 blades per set.</p>	<p>Length 520mm Hole 23mm Width 65mm Thick 6mm Step 10mm</p> 
<p><b>BR-06676</b> Replaces OEM 76529-34330, K5764- 34342, 76539-34372, 76550-34350, K5613-34340,</p>	<p>Fits <b>54" Deck</b> Zd331, ZD321, RC54-G20, RC54-B, RC54-F19, FZ21, ZD18, G1900. Z421, Z422KW Stepped &amp; Fluted, Right Hand cut</p> <p>Requires 3 blades per set.</p>	<p>Length 473mm Hole 29mm Width 65mm Thick 6mm Step 10mm</p> 
<p><b>BR-06676-23</b> Replaces OEM K5351-34330, K5351-34342</p>	<p>Fits <b>54" Deck</b> Bx2230, BX23, G2160, G2460, BX22, BX2700, RCK54-22BX, Bx1800. Stepped &amp; Fluted, Right Hand cut</p> <p>Requires 3 blades per set.</p>	<p>Length 475mm Hole 23mm Width 65mm Thick 6mm Step 10mm</p> 
<p><b>BR-08940</b> Replaces OEM K5619-34350 K5935-34360 K5351-99040</p>	<p>Fits Kubota <b>54" Deck</b> RCK54P-227Z etc. ZD221, ZG223, ZG227, Zd1011, ZD321N, RCK54P-321Z etc Stepped Blade Right Hand cut Requires 3 blades per set. <b>Use BRA-09120 Bolt &amp; BRA-09119 Washer</b></p>	<p>Length 473mm Hole 23mm Width 65mm Thick 6mm Step 10mm</p> 
<p><b>BR-09012</b> Replaces OEM K5617-34330, K5617-97530</p>	<p><b>54" Deck</b> Zg127, Z125, Z251BR, Z251KH, RCK54-23ZG, RCK54P-127ZA, Z100 series Stepped &amp; Fluted, Right Hand cut Requires 3 blades per set.</p>	<p>Length 473mm Hole 18mm Width 65mm Thick 6mm Step 10mm</p> 
<p><b>BR-01132</b> Replaces OEM 76500-34330, 70722-343374</p>	<p><b>48" Deck</b> RC48G, RC48-62A, 62H, G20 Stepped &amp; Fluted, Right Hand cut</p> <p>Requires 3 blades per set.</p>	<p>Length 420mm Hole 18mm Width 50mm Thick 5mm Step 22mm</p> 
<p><b>BR-06673</b> Replaces OEM 76505-34330, 70722- 34374, 70000-25005, K5182-71820</p>	<p><b>48" Deck</b> TG1860, G1800, G1900, BX2350, RC48G, RC48-62G, 62H Stepped &amp; Fluted Blade Right Hand cut Requires 3 blades per set</p>	<p>Length 420mm Hole 18mm Width 50mm Thick 5mm Step 8mm</p> 

<p><b>BR-09312</b> Replaces OEM K5575-34330, K5575-97530, K5579-92330, K5579-92332</p>	<p><b>48" Deck.</b> G6 Gator 392-047 Stepped &amp; Mulch Blade. Requires 3 Per Set. TG1860, G1800, G1900, BX2350, RC48G, RC48-62G, 62H, RCK48-20ZG, RCK48GR, RCK48P-124Z, RCK48P18BX, RCK48S-222Z, RCK48S-222Z (ZG20), Zg2048, <i>(Blade is Oregon Gator, not ASP Boron)</i></p>	<p>Length 420mm Hole 18mm Width 75mm Thick 6mm Step 12mm</p> 
<p><b>BR-09259</b> Replaces OEM K5583-34340</p>	<p><b>48" Deck</b> Stepped &amp; Fluted Hi Lift Blade Right Hand cut Z411, Z723, RCK48P-400Z, RCK48p-723Z, Z412 Requires 3 blades per set</p>	<p>Length 422mm Hole 29mm Width 65mm Thick 7mm Step 17mm</p> 
<p><b>BR-08890</b> Replaces OEM K5576-34350 K5184-97532</p>	<p><b>48" Deck</b> Hi Lift ZG222, ZD221, Pro Deck, RCK48P-222Z, Gr2110, Gr2120 (<b>RCK48GR - CHECK HOLE SIZE</b>) Stepped &amp; Hi Lift Blade Right Hand cut Requires 3 blades per set <b>Use BRA-09120 Bolt &amp; BRA-09119 Washer</b></p>	<p>Length 422mm Hole 23mm Width 65mm Thick 7mm Step 17mm</p> 
<p><b>BR-09311</b> Replaces OEM K5184-97532, K5576-34340, K5576-34350, K5576-97530, K5915-34360, K5915-97530</p>	<p><b>48" Deck.</b> G5 Gator 592-124 Stepped &amp; Mulch Blade. Requires 3 Per Set. ZG222, ZD221, Pro Deck, RCK48P-222Z <i>(Blade is Oregon Gator, not ASP Boron)</i></p>	<p>Length 422mm Hole 23mm Width 75mm Thick 6mm Step 16mm</p> 
<p><b>BR-09115</b> Replaces OEM K5575-34330, K5182-71840, K5575-97530, K5579-34350</p>	<p><b>48" Deck</b> Z100 series, T2290, Zg2048 etc (<b>RCK48-GR CHECK HOLE SIZE</b>), RCK48-20ZG, RCK48-18BX, RCK48-222Z, RCK48P-124Z, Z231BR &amp; KH, Z122 &amp; Z123 Stepped &amp; Fluted Blade Right Hand cut Requires 3 blades per set</p>	<p>Length 422mm Hole 18mm Width 65mm Thick 7mm Step 17mm</p> 
<p><b>BR-01133</b> Replaces OEM K5142-71820, 70712-34330</p>	<p>Fits Kubota <b>44" Deck</b>, RC44G, RCK44LT Stepped &amp; Fluted Blade Right Hand cut  Requires 3 blades per set.</p>	<p>Length 385mm Hole 18mm Width 50mm Thick 5mm Step 10mm</p> 
<p><b>BR-09230</b> Replaces OEM K5559-3433 K5700-34375 Bolt K5112-71333 Washer</p>	<p><b>42" Deck</b> Z122R, Z231KW, RCK42P-122Z Stepped &amp; Fluted Blade Right Hand cut Requires 2 blades per set</p>	<p>Length 546mm Hole 18mm Width 65mm Thick 6mm Step 11mm</p> 
<p><b>BR-01560</b> Replaces OEM 70000-25010, K5112-71920 K5111-71940</p>	<p>Fits Kubota <b>40 Deck</b> RC40LT, T1400H, T1460, T1560, T1700H Stepped &amp; Fluted Blade Right Hand cut  Requires 2 per set.</p>	<p>Length 517mm Hole 18mm Width 65mm Thick 6mm Step 10mm</p> 
<p><b>BRA-K6845</b> &amp; <b>BRA-K6846</b></p>	<p>BRA-K6845 Bolt suit some Blades with 29mm hole Replaces OEM 76539-34372, K5651-34372, K5651-34370  BRA-K6846 Washer suit various Replaces OEM 76550-34350 &amp; K5651-34350, K5651-34352</p>	
<p><b>BRA-09120</b> &amp; <b>BRA-09119</b></p>	<p>BRA-09120 Bolt suit some Blades Replaces OEM K5371-34372  BRA-09119 Washer suit various Replaces OEM K5371-34352</p>	

# MASSEY FERGUSON



Part Number	Description	
<b>BR-07162A</b>	<b>72" Deck</b> Zt29, ZT33 Stepped & Fluted Blade RH cut  Requires 3 per set	Length 628mm Hole 20mm Width 60mm Thick 7mm Step 15mm  
<b>BR-0525A</b> Replaces OEM 3606888MZ	<b>60" Deck</b> ZT29, ZT33 Stepped & Fluted Blade RH cut  Requires 3 per set	Length 527mm Hole 20mm Width 60mm Thick 7mm Step 15mm  
<b>BR-08963</b> Replaces OEM	<b>50" Deck. ZTR</b> Stepped & Fluted. Right Hand cut.  Requires 3 blades per set <i>(Replaces the OEM 6 point star hole)</i>	Length 452mm Hole Suits the 6Pt Star Width 65mm Thick 5mm Step 24mm   <b>BoronBlue™ Mulcher Blades</b>
<b>BR-115227A</b> Replaces OEM	<b>42" Deck MF42-20SD</b> Mulcher Blade & Side Discharge Right Hand cut Requires 2 per set. <i>(Replaces the OEM 6 point star hole)</i>	Length 539mm Hole Suits the 6Pt star Width 70mm Thick 4mm Step N/A  
<b>BR-115225A</b> Replaces OEM	<b>38" Deck MF38-15SD</b> Mulcher Blade & Side Discharge Right Hand cut Requires 2 per set. <i>(Replaces the OEM 6 point star hole)</i>	Length 491mm Hole Suits the 6Pt star Width 70mm Thick 4mm Step N/A  
	<h2>MEAN GREEN</h2>	
<b>BR-09332</b> Replaces OEM	<b>60" Deck ECOTEQ / MEAN GREEN RIVAL</b> Side Discharge, Right Hand cut. Requires 3 USE WITH: BRA-09337 FLAT WASHER BRA-09338 SPRING WASHER BRA-09336 BOLT	Length 524mm Hole 2 X 9.5mm & 12mm elongated Centre Hole Width 50mm Thick 5mm Step N/A  

## LOOKING FOR BLADES TO SUIT YOUR ELECTRIC MOWER?

Talk to one of our sales team today!

Free Call 1800 253 229 or email [sales@asproducts.com.au](mailto:sales@asproducts.com.au)

		<b>MTD</b>			
<b>Part Number</b>	<b>Description</b>				
<b>BR-08963</b> Replaces OEM 742-04053A, 942-04053B	<b>50" Deck.</b> 2004 on Deep Deck Stepped & Fluted. Right Hand cut.  Requires 3 blades per set <i>(Replaces the OEM 6 point star hole)</i>	Length Hole Width Thick Step	452mm Suits the 6Pt Star 65mm 5mm 24mm	 <b>BoronBlue™ Mulcher Blades</b>	
<b>BR-115227A</b> Replaces OEM 742-0616, 942-0616, 942-04312	<b>42" Deck</b> Mulcher Blade & Side Discharge Right Hand cut Requires 2 per set. <i>(Replaces the OEM 6 point star hole)</i>	Length Hole Width Thick Step	539mm Suits the 6Pt star 70mm 4mm N/A		
<b>BR-115225A</b> Replaces OEM 742-0610, 942-0610	<b>38" Deck</b> Mulcher Blade & Side Discharge Right Hand cut Requires 2 per set. <i>(Replaces the OEM 6 point star hole)</i>	Length Hole Width Thick Step	491mm Suits the 6Pt star 70mm 4mm N/A		
		<b>NEW HOLLAND</b>			
<b>Part Number</b>	<b>Description</b>				
<b>BR-07473</b>	<b>72" Deck</b> Flat Fluted Right Hand cut Requires 3 blades per set  Replaces OEM: AUB163380, 163442	Length Hole Width Thick Step	632mm 23mm 65mm 8mm N/A		
<b>BR-09019</b> Replaces OEM AUB163380, 163442 - has a 20mm step the BR-09019 is 10mm	<b>72" Deck</b> Stepped Mulcher Right Hand cut  Requires 3 blades per set	Length Hole Width Thick Step	632mm 23mm 60mm 8mm 10mm	 <b>BoronBlue™ Mulcher Blades</b>	
<b>BR-07473S</b> Replaces OEM AUB163380, 163442 - has a 20mm step the BR-07473S is 10mm	<b>72" Deck</b> Stepped & Fluted Right Hand cut  Requires 3 blades per set	Length Hole Width Thick Step	632mm 23mm 60mm 8mm 10mm		
<b>BR-01588</b> Replaces OEM 162836	<b>60" Deck</b> Flat Fluted Right Hand cut  Requires 3 blades per set	Length Hole Width Thick Step	517mm 18mm 50mm 6mm N/A		
<b>BR-01560</b> Replaces OEM 162122, 914, 914A	<b>60" Deck</b> Fm60, CM224, CM274 Stepped & Fluted RH cut Requires 3 blades per set "Early Deck"	Length Hole Width Thick Step	517mm 18mm 65mm 6mm 10mm		









**Part Number**

**NEW HOLLAND** Continued

<p><b>BR-06020</b> Replaces OEM 162122, 914, 914A</p>	<p><b>60" Deck</b> Fm60, CM224, CM274 Stepped &amp; Fluted Right Hand cut Requires 3 blades per set. "Late Deck"</p>	<p>Length 517mm Hole 23mm Width 65mm Thick 6mm Step 10mm</p> 
<p><b>BR-06677</b> Replaces OEM SBA645310330</p>	<p><b>60" deck,</b> 230GM, TZ25DA Stepped &amp; Fluted Right Hand cut Requires 3 blades per set</p>	<p>Length 520mm Hole 29mm Width 65mm Thick 7mm Step 14mm</p> 
<p><b>BR-09020</b> Replaces OEM</p>	<p>Mulch blade alternative to BR-06677 Requires 3 Blades</p>	<p>Length 520mm Hole 29mm Width 65mm Thick 7mm Step 14mm</p>  <p><b>BoronBlue™ Mulcher Blades</b></p>
<p><b>Part Number</b></p>	<p><b>SCAG</b>  <b>Description</b></p>	
<p><b>BR-08207</b> Replaces OEM 481709, 48112, 48113</p>	<p><b>72" Deck</b> Flat &amp; Fluted Blade Right Hand cut  Requires 3 blades per set.</p>	<p>Length 621mm Hole 16mm Width 65mm Thick 8mm Step N/A</p> 
<p><b>BR-08311</b> Replaces OEM 482879, 48111, 481708,</p>	<p><b>61" Deck</b> Stepped &amp; Fluted Blade Right Hand cut  Requires 3 blades per set.</p>	<p>Length 536mm Hole 16mm Width 65mm Thick 6mm Step 6mm</p> 
<p><b>BR-D18037</b> Replaces OEM 48108, 481707, 482462, <b>483317 36" Deck</b></p>	<p><b>52" and 36" Decks</b> Flat &amp; Fluted Blade Right Hand cut  Requires 3 per set for 52" and 2 per set for 36"</p>	<p>Length 457mm Hole 16mm Width 65mm Thick 5mm Step N/A</p> 
<p><b>BR-08891</b> Replaces OEM 48108, 481707, 482462 <b>483317 36" Deck</b></p>	<p><b>52" and 36" Decks</b> Razorback Mulcher Blade Right Hand cut  Requires 3 per set for 52" and 2 per set for 36"</p>	<p>Length 457mm Hole 16mm Width 65mm Thick 5mm Step 4mm</p>  <p><b>BoronBlue™ Mulcher Blades</b></p>
<p><b>BR-08407</b> Replaces OEM 48110, 48084, 481706</p>	<p><b>48" and 32" Decks</b> Stepped &amp; Fluted Blade Right Hand cut  Requires 3 per set for 48" and 2 per set for 32"</p>	<p>Length 418mm Hole 16mm Width 65mm Thick 6mm Step N/A</p> 

ALL BLADES ARE SOLD AS SINGLES (INDIVIDUALLY) PLEASE ORDER THE QUANTITY REQUIRED TO MAKE UP A SET.

OEM Reference numbers are used for identification only, we also encourage you to check blade dimensions prior to ordering.  
ASP blades are not sold as genuine.

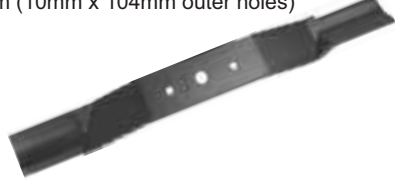
<h1>SHIBAURA</h1>			
Part Number	Description		
<b>BR-07129</b> Replaces OEM	<b>72" Deck</b> Stepped & Fluted Blade Right Hand cut  Requires 3 Blades per set.	Length 620mm Hole 23mm Width 60mm Thick 7mm Step 12mm	
<b>BR-06677</b> Replaces OEM SBA645310221	<b>60" Deck</b> TMM60Y, ST321, ST325 Flat & Fluted Blade Right Hand cut  Requires 3 Blades per set.	Length 520mm Hole 29mm Width 65mm Thick 7mm Step 14mm	
<b>BR-01588</b> Replaces OEM	<b>60" Deck</b> SX24 Stepped & Fluted Blade Right Hand cut  Requires 3 Blades per set.	Length 517mm Hole 18mm Width 50mm Thick 6mm Step N/A	
<b>BR-06676</b> Replaces OEM	<b>54" Deck</b> SX21 Stepped & Fluted Blade Right Hand cut  Requires 3 Blades per set.	Length 473mm Hole 29mm Width 65mm Thick 6mm Step 10mm	
<h1>SUPERIOR</h1>			
Part Number	Description		
<b>BR-07503</b> Replaces OEM S1611, S3690	<b>12' Trimdeck Contractor</b> Stepped & Fluted LH cut Requires 3 per set  Use BOLT KIT BRA-08067 (inc. 2 x bolts & nuts)	Length 791mm (14mm x 134mm outer holes) Hole 17.5mm Width 75mm Thick 8mm Step 20mm	
<b>BR-07500</b> Replaces OEM S1631	<b>6' Outfront</b> Stepped & Fluted Blade LH cut Requires 3 per set  Use BOLT KIT BRA-08066 (inc. 2 x bolts & nuts)	Length 632mm (11mm x 104mm outer holes) Hole 17mm Width 75mm Thick 8mm Step 20mm	
<b>BR-07502</b> Replaces OEM S1508	<b>5' Trim Deck</b> Stepped & Fluted Blade LH cut Requires 3 per set.  Use BOLT KIT BRA-08066 (inc. 2 x bolts & nuts)	Length 510mm (10mm x 104mm outer holes) Hole 16mm Width 65mm Thick 6mm Step 16mm	



# TORO



Part Number	Description	
<b>BR-09282</b> Replaces OEM 100-5754-03, 104-5183, 105-4089, 105-4089-03, 105-9810, 105-9810-03, 105-9810-05, 107-0235-03, 108-9026-03	<b>4700-D, 4500-D &amp; 3500-D WIDE AREA MOWERS.</b> Stepped & Fluted. 30807, 30809, 30849, 30881, 30882 7 blades required Use BRA-09276 Anti Scalp Plate (OEM Ref 72-9361)	Length 685mm Hole 13mm Width 64mm Thick 6mm Step 11mm  <b>COMING SOON</b>
<b>BR-09317</b> Replaces OEM 100-5754-03, 104-5183, 105-4089, 105-4089-03, 105-9810, 105-9810-03, 105-9810-05, 107-0235-03, 108-9026-03	<b>4700-D, 4500-D &amp; 3500-D WIDE AREA MOWERS.</b> G3 Gator 96-741 Stepped & Mulch Blade. 30807, 30809, 30849, 30881, 30882 Use BRA-09276 Anti Scalp Plate (OEM Ref 72-9361) <i>(Blade is Oregon Gator, not ASP Boron)</i>	Length 685mm Hole 13mm Width 64mm Thick 6mm Step 11mm 
<b>BR-08834</b> Replaces OEM 110-5946	Fits Toro <b>16'</b> Groundsmaster 5900/5910 Stepped & Fluted Blade RH cut Requires 11 per set.  Use Blade Bolt BRA-08806, Washer BRA-08809 Use BRA-09278 Anti Scalp Plate	Length 504mm Hole 13mm Width 65mm Thick 6mm Step 15mm 
<b>BR-09122</b> Replaces OEM 110-5948	MULCH Toro <b>16'</b> Groundsmaster 5900/5910 Stepped & Fluted Blade RH cut Requires 11 per set.  Use Blade Bolt BRA-08806, Washer BRA-08809 Use BRA-09278 Anti Scalp Plate	Length 504mm Hole 13mm Width 65mm Thick 6mm Step 15mm  <b>BoronBlue™ Mulcher Blades</b>
<b>BR-09163</b> Replaces OEM 130-9151	Fits Toro <b>16'</b> Groundsmaster <b>NEW</b> model 5900/5910, 31699 Stepped & Fluted Blade RH cut Requires 11 per set. Use BRA-09278 Anti Scalp Plate Use Blade Bolt BRA-08806, Washer BRA-08809	Length 504mm Hole 13mm Width 65mm Thick 6mm Step <b>6mm</b> 
<b>BR-08695</b> Replaces OEM 92-5608, 107-0214 <b>BR-08695NF</b> OEM 110-6115-03	Toro <b>4000D &amp; 4010 &amp; 62" Decks (3 blades)</b> <b>4000D &amp; 4010 Model 30410 requires 7 per set.</b> Also <b>62" Rear Discharge</b> & recycler 7200 / 7210 <b>BR-08695NF is a NO FLUTE OPTION</b> Use BRA-09278 Anti Scalp Plate Use Blade Bolt BRA-08806, Washer BRA-08809	Length 552mm Hole 13mm Width 65mm Thick 6mm Step 15mm  BR-08695 BR-08695NF
<b>BR-09121</b> Replaces OEM 92-5608, 107-0214	MULCH blade Fits Toro <b>132" &amp; 62" DECKS</b> 4000D & 4010 Model 30410 requires 7 per set. Also <b>62" Rear Discharge</b> 7200 / 7210 & 62" Recycler, requires 3 blades Use BRA-09278 Anti Scalp Plate Use Blade Bolt BRA-08806, Washer BRA-08809	Length 552mm Hole 13mm Width 65mm Thick 6mm Step 15mm  <b>BoronBlue™ Mulcher Blades</b>
<b>BR-09277</b> Replaces OEM 140-1246	Fits Toro <b>96" DECKS</b> 7500-D Model 72098  MULCH blade. Requires 4 per set.  (Can use <b>BR-09237 STANDARD</b> Flute option)	Length 621mm Hole 24mm Width 65mm Thick 6mm Step 6mm  <b>BoronBlue™ Mulcher Blades</b>
<b>BRA-09278</b> Replaces OEM 72-9361	Anti Scalp Plate  Suits most Toro Blades with a 13mm Bolt Hole.	

<b>BR-08207</b> Replaces OEM 105-7711, 105-7784	<b>72" Deck Side Discharge</b> Z Master 74947, 74274, Z550-5970, Z550, Z558, Z589, Z597, 5000, 6000 & 7000 series 74918 & G3 with Holder. High Flow Blade RH cut Requires 3 per set. Flat & Fluted. Use Blade Bolt BRA-08808, Washer BRA-08807	Length 621mm Hole 16mm Width 64mm Thick 8mm Step N/A 
<b>BR-08726</b> Replaces OEM 105-7784	<b>72" Deck Z Master</b> Z550-5970, Z550, Z558, Z589, Z597, G3 Mulcher Blade RH cut requires 3 per set.  Use Blade Bolt BRA-08808, Washer BRA-08807	Length 621mm Hole 16mm Width 64mm Thick 7mm Step 6mm  <b>BoronBlue™  Mulcher Blades</b>
<b>BR-08720</b> Replaces OEM 110-0622, 110-0621	<b>72" Deck Side Discharge</b> Groundsmaster 7200 / 7210 Models & GM360, 30360, 30361, 30362, 30363, 30364, 30365. High Lift Heavy Duty Blade Flat, RH cut  Requires 3 per set.	Length 620mm Hole 13mm Width 64mm Thick 8mm Step N/A 
<b>BR-08727</b> Replaces OEM 110-0622, 140-4852, 110-0624	<b>72" Deck</b> Groundsmaster 7200 / 7210 Models & GM360, 30360, 30361, 3300 30362, 30363, 30364, 30365. Stepped Mulcher Blade RH cut Requires 3 per set.	Length 620mm Hole 13mm Width 64mm Thick 7mm Step 6mm  <b>BoronBlue™  Mulcher Blades</b>
<b>BR-09237</b> Replaces OEM 140-1238 Blade	<b>72" Deck High Flow Blade RH cut</b> 6000 series 72968, 72947, 7000 series 72274 & 7500D series 72076. requires 3 per set. Flat & Fluted. Use Blade Bolt BRA-08806, Washer BRA-08809 <b>(Can use BR-09277 MULCH option)</b>	Length 620mm Hole 24mm Width 64mm Thick 6mm Step N/A 
<b>BR-08515</b> Replaces OEM 110-0621	<b>72" Deck</b> Groundsmaster 3280 & 3320 Side Discharge. Model 3320, 30368 Stepped & Fluted Blade RH cut. Requires 3 per set. Use Blade Bolt BRA-08806, Washer BRA-08809 BRA-09278 Anti-Scalp Plate	Length 618mm Hole 13mm Width 65mm Thick 6mm Step 6mm 
<b>BR-06271</b> Replaces OEM 93-4982, 108-1958, 85-6040 121-5347, 125-9444	<b>72" Deck - Rear Discharge</b> Groundsmaster / Z Master, Guardian Recycler, 217D, 220D, 957D, 3320, 3280 Z597 & 7200 , Gm360. Use <b>BRA-09278</b> Anti Scalp Plate Stepped & Fluted Blade RH cut 3 per set Use Bolt BRA-08806, Washer BRA-08809	Length 639mm Hole 13mm Width 65mm Thick 6mm Step 6mm 
<b>BR-06271NF</b> Replaces OEM 112-9586-03	<b>72" Deck - Rear Discharge, NO FLUTE</b> Groundsmaster / Z Master, Guardian Recycler, 217D, 220D, 957D, 3320, 3280 Z597 & 7200 , Gm360. Stepped & Fluted Blade RH cut 3 per set. Use <b>BRA-09278</b> Anti Scalp Plate. Use Bolt BRA-08806, Washer BRA-08809	Length 639mm Hole 13mm Width 65mm Thick 6mm Step 6mm 
<b>BR-06251</b> Replaces OEM 44-6250	<b>62" Deck</b> Groundsmaster Z Master 220D, & 228D Side Discharge. Stepped & Fluted Blade RH cut requires 3 per set. Use Bolt BRA-08806, Washer BRA-08809	Length 545mm Hole 13mm Width 65mm Thick 6mm Step 6mm 
<b>BR-08210</b> Replaces OEM 105-7715, 105-7718, 105-7716, 103-0301, 133-2127, 115-9649	<b>60" Deck</b> 74958, 74950, 74955, 74945, 75318TA Z500, 74246-Z557, G3, Z587L, Z588E, Z597 & Z593, Z528, 5000, 6000 & 7000 series 74915 & 74930, Z558 with holder. Titan Zx6050 & Hd2000, 74946 Flat & Fluted R/H cut Requires 3 per set. Use Blade Bolt BRA-08808, Washer BRA-08807	Length 520mm Hole 16mm Width 63mm Thick 6mm Step N/A 

<b>BR-08910</b> Replaces OEM 105-7715, 105-7718, 105-7716, 103-0301, 105-7777, 105-8777	<b>60" Deck Mulcher</b> Z500, 74246-Z557, G3, Z587L, Z588E, Z597 & Z593, Z528, Z558 with holder. Requires 3 per set. Use Blade Bolt BRA-08808, Washer BRA-08807	Length 520mm Hole 16mm Width 63mm Thick 6mm Step N/A  <b>BoronBlue™ Mulcher Blades</b>
<b>BR-08516</b> Replaces OEM 110-4701 110-4702 High 110-4703 Mulch	<b>60" Deck</b> Groundsmaster 3280 & 3320, 31970 7200 / 7210 Flat & Fluted Blade RH cut  Requires 3 per set	Length 520mm Hole 13mm Width 63mm Thick 6mm Step 
<b>BR-09220</b> Replaces OEM	<b>60" Deck Mulcher</b> Groundsmaster 3280 & 3320, 7200 / 7210 Flat & Fluted Blade RH cut  Requires 3 per set	Length 520mm Hole 13mm Width 63mm Thick 6mm Step N/A  <b>BoronBlue™ Mulcher Blades</b>
<b>BR-09235</b> Replaces OEM 140-1240 Blade 109-9220 Bolt / Washer	<b>60" Deck Flat &amp; Fluted R/H cut</b> 3000 series 72950, 72936 6000 series 72960, 72967, 72946 7000 series 72267 Use Blade Bolt BRA-08806, Washer BRA-08809 Requires 3 per set	Length 520mm Hole 24mm Width 63mm Thick 6mm Step N/A 
<b>BR-09240</b> Replaces OEM 140-1241 Blade 109-9220 Bolt / Washer	<b>60" Deck REAR DISCHARGE, Right Hand cut</b> - requires 2 & 1 x BR-09241 Left hand 5000 series 72943 7500D 72028 Use Blade Bolt BRA-08806, Washer BRA-08809	Length 520mm Hole 24mm Width 63mm Thick 6mm Step N/A  <b>BoronBlue™ Mulcher Blades</b>
<b>BR-09241</b> Replaces OEM 140-1244 109-9220 Bolt / Washer	<b>60" Deck REAR DISCHARGE Deck</b> Flat & Fluted Blade <b>Left Hand cut</b> , use with 2 x BR-09240 blades. 7500, 72028 BRA-08806 Blade Bolt BRA-08809 Washer	Length 520mm Hole 24mm Width 65mm Thick 6mm Step N/A 
<b>BR-09242</b> Replaces OEM 115-9650 Blade 115-2454	<b>54" Deck Side Discharge</b> Time Cutter & Titan, 75212, 75312TA, 74740, 75317TA Flat & Fluted RH cut  Requires 3 blades per set	Length 475mm Hole 16mm Width 65mm Thick 5mm Step N/A 
<b>BR-09299</b> Replaces OEM 539112078, 573953001, 577146101	<b>54" Decks Flat Blade.</b> G3 Gator 96-803 Time Cutter & Titan, 75212, 75312TA  Flat & Fluted RH cut  <i>(Blade is Oregon Gator, not ASP Boron)</i>	Length 475mm Hole 16mm Width 65mm Thick 5mm Step N/A 
<b>BR-562390</b> Replaces OEM 56-2390, 27-0990	<b>52" &amp; 36" Decks</b> Groundsmaster Z153, Z149 & Walk Behinds. Flat & Fluted Blade RH cut  Requires 3 per set for 52", 2 per set for 36".	Length 456mm Hole 13mm Width 65mm Thick 5mm Step N/A 
<b>BR-09234</b> Replaces OEM 140-1242 Blade 109-9220 Bolt / Washer 109-6873	<b>52" Deck - 3000 &amp; 7000, 72949 &amp; 72266 Flat &amp; Fluted Blade RH cut</b> Requires 3 per set, Use Blade Bolt BRA-08806, Washer BRA-08809	Length 457mm Hole 24mm Width 63mm Thick 6mm Step N/A 

**Part Number**

**TORO Continued**

<p><b>BR-09245</b> Replaces OEM 140-4859 Blade 109-9220 Bolt / Washer</p>	<p><b>52" Deck</b> - 3000 &amp; 7000, 72949 &amp; 72266 Flat &amp; Fluted Blade RH cut Requires 3 per set, Use Blade Bolt BRA-08806, Washer BRA-08809</p>	<p>Length 457mm Hole 24mm Width 63mm Thick 6mm Step N/A</p>  <p><b>BoronBlue™ Mulcher Blades</b></p>
<p><b>BR-D18037</b> Replaces OEM 106-2174, 105-7781, 55-4210, 40-3760, 108-1117, 105- 7779, 133-2134</p>	<p><b>52" Deck</b> - Time Cutter 74806, 74906, 74955, ZX525, Z593D 453 Model &amp; GM117. 74505, 74466, 74906, 74949, 3000 &amp; 5000 &amp; Titan Flat &amp; Fluted Blade RH cut Requires 3 per set &amp; 2 for <b>36" GRANDSTAND</b> Use BRA-08938 Bolt &amp; BRA-08807 washer</p>	<p>Length 457mm Hole 16mm Width 65mm Thick 5mm Step N/A</p> 
<p><b>BR-08891</b> Replaces OEM 106-2174, 105-7781, 105-7779, 110-0409</p>	<p><b>52" Deck</b> Time Cutter 74806, ZX525, TITAN Z593D 453 Model &amp; Gm117. 2 for <b>36" GRANDSTAND</b> Mulcher Blade RH cut Requires 3 per set, Use BRA-08938 Bolt &amp; BRA-08807 washer</p>	<p>Length 457mm Hole 16mm Width 63mm Thick 6mm Step N/A</p>  <p><b>BoronBlue™ Mulcher Blades</b></p>
<p><b>BR-08980</b> Replaces OEM 110-6837 115-5059 140-5134</p>	<p><b>50" Deck, 3 Blades &amp; 34" Deck, 2 Blades</b> MX5050 &amp; MX 3450 Timecutter Z5000 SERIES 74370 &amp; 75730TA  Flat &amp; Fluted Blade RH cut</p>	<p>Length 445mm Hole 16mm Width 60mm Thick 6mm Step 3mm</p> 
<p><b>BR-09233</b> Replaces OEM 140-1243 Blade 109-9220 Bolt / Washer</p>	<p><b>48" Deck</b> 3000 series, 72952. 4000, 74000 &amp; Grandstand, 74000TA Flat &amp; Fluted Blade RH cut Requires 3 per set. Use Blade Bolt BRA-08806, Washer BRA-08809</p>	<p>Length 418mm Hole 24mm Width 63mm Thick 6mm Step N/A</p> 
<p><b>BR-09246</b> Replaces OEM 140-1243 Blade 109-9220 Bolt / Washer</p>	<p><b>48" Deck Mulch</b> 3000 series, 72952. 4000, 74000 &amp; Grandstand, 74000TA Flat Mulch Blade RH cut Requires 3 per set. Use Blade Bolt BRA-08806, Washer BRA-08809</p>	<p>Length 418mm Hole 24mm Width 63mm Thick 6mm Step N/A</p> 
<p><b>BR-08407</b> Replaces OEM 107-3192, 107-3193 107-3194, 133-2137, 117-7277</p>	<p><b>48" Deck</b> Titan HD 2000 series, Z master etc 74412-Z400, &amp; 74417 Z450, 3000, 77280 G3 Z Master. ZX4820, Zx4800 Flat &amp; Fluted Blade RH cut Requires 3 per set. Use Blade Bolt BRA-08808, Washer BRA-08807</p>	<p>Length 418mm Hole 16mm Width 63mm Thick 6mm Step N/A</p> 
<p><b>BR-08895</b> Replaces OEM 107-3192, 107-3193 107-3194</p>	<p><b>48" Deck</b> 74412-Z400, &amp; 74417 Z450, Zx4800 &amp; ZX4820, 3000, G3 Z Master Mulcher Blade Requires 3 per set. Use Blade Bolt BRA-08808, Washer BRA-08807</p>	<p>Length 418mm Hole 16mm Width 63mm Thick 6mm Step N/A</p>  <p><b>BoronBlue™ Mulcher Blades</b></p>

Don't forget your  
Trimmer Line!

See page 82 for  
details





**Part Number**



**TORO Continued**

<p><b>BR-08546 LH</b> Replaces OEM 130-2861</p> <p><b>BR-08547 RH</b> Replaces OEM 130.2862</p>	<p><b>48" Deck</b> 8000 Series &amp; Navigator Stepped &amp; Fluted Require: 1 x BR-08546 &amp; 1 x BR-08547 For Catcher</p>	<p>Length 640mm (7.5mm holes @ 76mm centres) Hole 23mm Width 60mm Thick 5mm Step 20mm</p> 
<p><b>BR-08463</b> Replaces OEM 106-2247, 106-8744 131-3939-03 (High Lift)</p>	<p><b>42" Deck</b> Mx4260, Z4220, Time Cutter 74403-Z420, 74403-16-42Z, Z4200 Flat &amp; Fluted Blade RH cut Requires 2 per set</p>	<p>Length 548mm Hole 16mm Width 60mm Thick 5mm Step 12mm</p> 
<p><b>BR-08504 LH</b> Replaces OEM 130-2860</p> <p><b>BR-08505 RH</b> Replaces OEM 130-2859</p>	<p><b>42" Deck</b> 8000 Series &amp; Navigator Stepped &amp; Fluted Require: 1 x BR-08504 &amp; 1 x BR-08505 For Catcher</p>	<p>Length 560mm (7.5mm holes @ 76mm centres) Hole 23mm Width 60mm Thick 5mm Step 20mm</p> 
<p><b>BR-09297</b> Replaces OEM 116-6358-03</p>	<p><b>30" Deck</b> TimeMaster 20199 , 20200 , 2014 30" cut TurfMaster Walk Behind Mowers Step Mulch Blade RH cut Requires 2 per set</p>	<p>Length 389mm Centre Hole 16mm (2 x Outer Holes 7.5mm) Width 64mm Thick 4mm Step 11mm</p>  <p><b>NEW</b></p>

**VENTRAC**

<p><b>Part Number</b></p>	<p><b>Description</b></p>	
<p><b>BR-09015</b> Replaces OEM 79.0048</p>	<p>Suits Ventrac Mower Tough Cut Flat, Double edge blade LH &amp; RH cut</p>	<p>Length 584mm Hole 13mm Width 65mm Thick 8mm Step N/A</p> 

**WALKER**

<p><b>Part Number</b></p>	<p><b>Description</b></p>	
<p><b>BR-08222 LH</b> Replaces OEM 7705-2</p> <p><b>BR-08223 RH</b> Replaces OEM 7705-1</p>	<p><b>48" Deck 08222 LEFT Hand &amp; 08223 RIGHT Hand, Stepped &amp; Fluted LH cut</b> Require: 1 x BR-08223 &amp; 1 x BR-08222 For GHS  <i>Use BRA-08239 Shear bolt &amp; BRA-08240 nut</i></p>	<p>Length 640mm (5.5mm holes @ 76mm centres) Hole 16mm Width 60mm Thick 5mm Step 20mm</p> 
<p><b>BR-355032 LH</b> Replaces OEM 5705-4</p> <p><b>BR-355024 RH</b> Replaces OEM 5705-3</p>	<p><b>42" Deck 355032 LEFT Hand &amp; 355024 RIGHT Hand. Stepped &amp; Fluted LH cut</b> Require 1 x BR-355032 &amp; 1 x BR-355024 for GHS  <i>Use BRA-08239 Shear bolt &amp; BRA-08240 nut</i></p>	<p>Length 560mm (5.5mm holes @ 76mm centres) Hole 16mm Width 60mm Thick 5mm Step 20mm</p> 

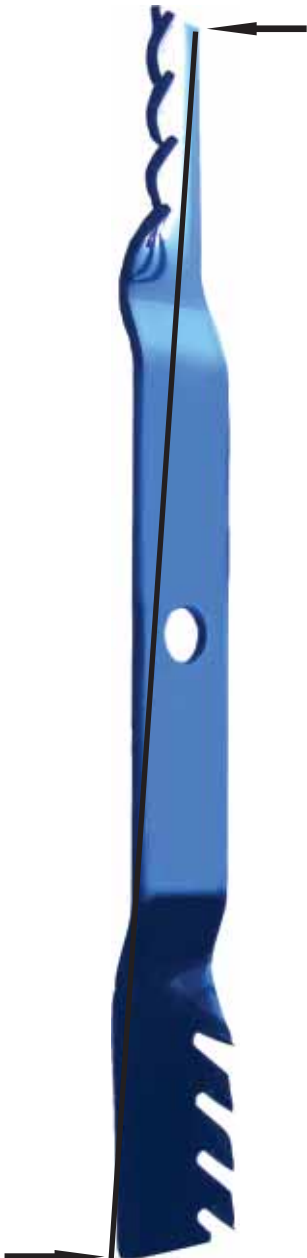

LENGTH IS MEASURED TIP TO TIP







LENGTH	HOLE	STEP	WIDTH	THICK	PART NUMBER
372	SPT STAR	0	65	5	BR-08957
379	18	0	63	5	BR-09303
385	18	10	50	5	BR-01133
389	16	11	64	4	BR-09297
397	16	0	70	5	BR-09307
412	SPT STAR	0	65	5	BR-08956
413	16	0	75	6	BR-09304
418	16	0	65	6	BR-08407
418	16	0	65	7	BR-08895
420	18	22	50	5	BR-01132
420	18	10	65	6	BR-09312
422	29	17	65	7	BR-09259
422	23	16	75	6	BR-09311
422	18	17	65	7	BR-09115
422	18	8	65	5	BR-06673
422	23	17	65	7	BR-08890
424	SPT STAR	0	64	5	BR-09319
430	21	7	65	5	BR-127500
430	23	17	65	6	BR-08701
432	7PT STAR	6	63	5	BR-09298
432	19	11	75	6	BR-09313
452	6PT STAR	24	65	5	BR-08963
445	16	3	60	6	BR-08980
451	SPT STAR	0	75	4	BR-09306
456	13	0	65	5	BR-562390
457	16	0	65	5	BR-D18037
457	16	0	65	6	BR-08891
457	24	0	63	6	BR-09234
469	SPT STAR	12	64	5	BR-09302
470	16	0	65	6	BR-08951
470	23	10	65	6	BR-08940
472	29	10	65	6	BR-06676
473	21	7	65	5	BR-330365
473	23	10	65	6	BR-06676-23
473	18	10	65	6	BR-09012
475	16	0	65	5	BR-09242
480	20	10	65	6	BR-08962
480	13	6	65	6	BR-08552
481	20	12	75	6	BR-09309
483	23	7	65	5	BR-08470
483	23	10	75	6	BR-09310
483	19	15	75	5	BR-09314
489	SPT STAR	0	65	5	BR-08957
494	18	7	75	5	BR-330397
494	18	7	65	5	BR-330290
495	18	10	75	6	BR-09308
504	13	15	65	6	BR-08834
504	13	6	65	6	BR-09163
510	16	16	65	6	BR-07502
517	18	0	50	6	BR-01588
517	23	7	65	6	BR-06020
517	18	10	65	6	BR-01560
518	13	6	65	6	BR-08516
520	16	0	65	6	BR-08952
520	16	0	65	7	BR-08910
520	34	14	65	7	BR-09078

LENGTH	HOLE	STEP	WIDTH	THICK	PART NUMBER
520	29	14	65	7	BR-06577
520	16	0	63	6	BR-08210
520	24	0	63	6	BR-09235
521	23	0	65	6	BR-06253
527	20	15	60	7	BR-0525A
532	16	6	65	6	BR-D18036
533	19	13	75	5	BR-09315
533	SPT STAR	0	75	4	BR-09300
533	23	10	65	8	BR-128485
535	SPT STAR	0	57	4	BR-08224
536	16	6	65	6	BR-08311
539	6PT STAR	0	70	4	BR-115227A
543	20	0	65	4.5	BR-09183
543	7PT STAR	0	65	4	BR-08756
545	17	0	65	5	BR-20249
546	18	11	65	6	BR-09230
548	16	0	60	5	BR-08463
550	13	15	65	6	BR-08695
550	13	15	65	6	BR-08695NF
555	23	8	65	8	BR-08560
560	23	20	60	6	BR-08546
560	23	20	60	6	BR-08547
560	16	20	60	5	BR-355024
560	16	20	60	5	BR-355032
581	SPT STAR	8	70	4	BR-09301
606	16	0	65	6	BR-08954
618	13	6	65	6	BR-08515
620	24	0	64	6	BR-09237
621	24	6	65	6	BR-09277
620	13	0	63	8	BR-08720
620	13	10	65	6	BR-08727
620	23	12	60	7	BR-07129
621	16	10	65	6	BR-08726
621	16	0	65	8	BR-08207
621	16	10	65	6	BR-08726
622	34	14	65	7	BR-09077
622	29	15	75	7	BR-08826
622	29	14	65	7	BR-07462
622	29	14	65	7	BR-08703
622	34	15	75	7	BR-09085
628	20	15	60	7	BR-07162A
630	16	6	65	6	BR-08217
630	23	10	60	8	BR-07473S
632	23	0	65	8	BR-07473
632	17	20	75	8	BR-07500
634	23	15	75	7	BR-08772
634	23	7	65	8	BR-08466
639	13	6	65	7	BR-06271
639	13	6	65	6	BR-06271NF
640	23	23	60	6	BR-08504
640	23	23	60	6	BR-08505
640	16	23	60	6	BR-08222
640	16	23	60	6	BR-08223
685	13	11	64	6	BR-09317
791	17.5	20	75	8	BR-07503



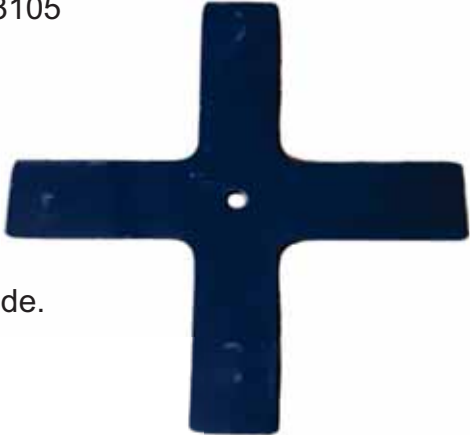
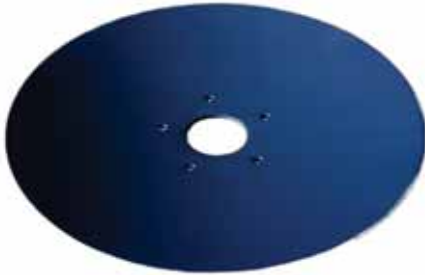

## EDGER BLADES

Part Number	Description	
BM-802310	Edger blade. OEM Ref L129 Suits Little Wonder, Kawasaki, MTD, Masport, Toro etc. Blades are 250mm long, 45mm wide, 3mm thick and have a 13mm hole.	
BM-802720	Edger blade. OEM Ref ME63222G Suits Victa etc. Blades are 250mm long, 50mm wide, 3mm thick and have a 16mm hole.	
BM-09137	Edger blade. Suits Various. Blades are 300mm long, 50mm wide, 3mm thick and have a 16mm hole.	
BM-08908	Edger blade. Stihl OEM 41337134102 Suits Ryobi, Shindaiwa, Stihl & Husq. Combi ECA850 & ESA850 Blades are 195mm long, 50mm wide, 3mm thick and have a 25mm hole.	
<b>BM-08565</b>	Edger blade to suit Atom edgers. OEM Ref 43105 One piece heavy duty steel blade. <b>2.5mm thick steel</b> 265mm long x 13mm hole x 45mm wide	
<b>BM-08326</b>	Edger blade to suit Atom edgers. OEM Ref 43105 One piece extra heavy duty BORON steel blade. <b>3mm thick steel</b> 265mm long x 13mm hole x 45mm wide	
		
		
<b>ASP-1069</b>	Gyral Edger Disc. OEM Ref T1679 Disc's are 13" diameter, 52mm round centre hole with 5 X 7mm radial holes at 94mm PCD. 27mm Dish Depth. BORON steel.	



# LIGHTNING TRIMMER LINE

Professional Grade trimmer line for ultimate performance & durability!

ASP heavy duty 'Lightning Line' is the perfect choice for commercial operators, offering resistance to fraying, welding & breakage. Delivering efficient cuts at affordable pricing.

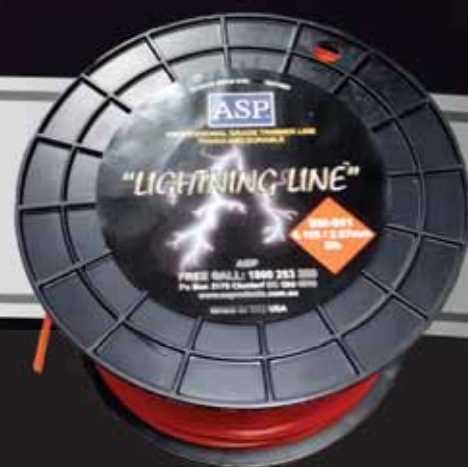

Available in 1lb, 3lb & 5lb rolls  
2.4mm, 2.7mm, 3.0mm, 3.3mm &  
4.0mm

Made in the USA



## ROUND

BM-826	2.0mm	1lb	90mtr
BM-813	2.4mm	1lb	80mtr
BM-814	2.7mm	1lb	70mtr
BM-815	3.0mm	1lb	54mtr
BM-816	2.4mm	3lb	256mtr
BM-817	2.7mm	3lb	210mtr
BM-818	3.0mm	3lb	163mtr
BM-819	2.4mm	5lb	427mtr
BM-820	2.7mm	5lb	350mtr
BM-821	3.0mm	5lb	272mtr
BM-822	3.3mm	5lb	269mtr
BM-860	4.0mm	5lb	150mtr



## DIAMOND

BM-834	2.4mm	1lb	70mtr
BM-835	2.7mm	1lb	66mtr
BM-836	3.0mm	1lb	54mtr
BM-837	2.4mm	3lb	241mtr
BM-838	2.7mm	3lb	198mtr
BM-839	3.0mm	3lb	163mtr
BM-840	2.4mm	5lb	401mtr
BM-841	2.7mm	5lb	329mtr
BM-842	3.0mm	5lb	273mtr
BM-843	3.3mm	5lb	240mtr
BM-862	4.0mm	5lb	140mtr

[www.asproducts.com.au](http://www.asproducts.com.au)

# F-ONE SERIES BUMP FEED HEADS

Made in Italy - Professional Grade

## ✓ INNOVATIVE "LINE SHIELDER"

Stops the line from breaking at the eyelets, therefore preventing it from going back inside the head, assuring a continuous job without interruption.

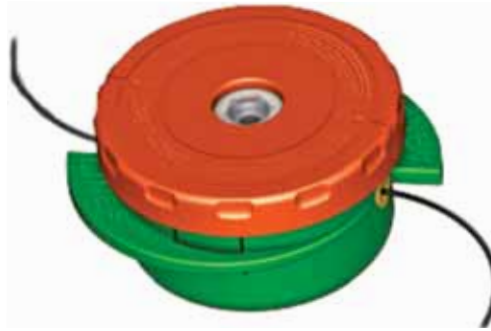

LINE NEVER BREAKS AT THE EYELET!

## ✓ RC SYSTEM: EASY RETOOLING

Simply line up the arrow with the eyelet, then thread the line through the head, making sure that both lengths are equal on either side. Just by twisting the head the line is wound onto the spool. It's very easy, no need to take the head apart!

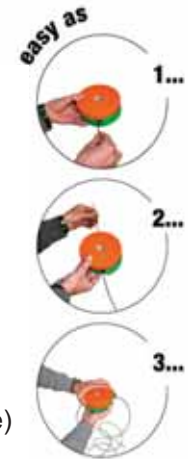

... GO!

PART NUMBER      THREAD SIZE

### F-ONE 396 (4 INCH) HEADS

BM-08897	8X1.25MLH
BM-08898	10X1.25MLH
BM-08899	8X1.25FLH
BM-08900	10X1.00FLH
BM-08901	10X1.25FLH
BM-09374	12X1.25FLH
BM-09375	12X1.50FLH
BM-09376	12X1.75FLH

BM-09377	UNIVERSAL FIT (Fits like a cutting blade)
BM-101279	Replacement Face for above Heads

### F-ONE 596 (4 1/2" INCH) HEADS

BM-09378	596 SERIES LARGE HEAD 10X1.00FLH
BM-09379	596 SERIES LARGE HEAD 10X1.25FLH

Max line size 4.0mm (Round)

# UNIVERSAL BUMP FEED HEADS

## SPEED FEED 400



### BM-08900SF

- Loads in 30 seconds
  - Rugged semi-matic head for medium to h/duty applications
  - Inner wall reduces amount of dirt inside head
  - Large, durable eyelets enhance line life
  - Line tensioning system with split spool reduces vibration
  - Holds 10 feet of .095" line (Max line size 2.7mm)
- Fits: Most straight shaft brushcutters.  
Diameter: 4"

Kit Consists of:

- 1 x M10 x 1.25 LHF
- 1 x M10 x 1.00 LHF
- 1 x M8 x 1.25 LHF
- 1 x Stud 8mm x 1.25 LHM
- 1 x Stud 7mm x 1.00 LHM

**BM-08900SF-B**  
REPLACEMENT COVER

## SPEED FEED 450



### BM-09280SF

- Loads in 30 seconds
  - Rugged semi-matic head for medium to h/duty applications
  - Inner wall reduces amount of dirt inside head
  - Large, durable eyelets enhance line life
  - Line tensioning system with split spool reduces vibration
  - Holds 20 feet of .095" line (Max line size 2.7mm)
- Fits: Most straight shaft brushcutters.  
Diameter: 4 1/2", 114.3 mm

Kit Consists of:

- 1 x M10 x 1.25 LHF
- 1 x M10 x 1.25 LHF
- 1 x Stud 8mm x 1.25 LHM
- 1 x Stud 7mm x 1.00 LHM
- 1 x M10 x 1.00 LHF

**BM-09280SF-B**  
REPLACEMENT COVER

# TRIMMER HEADS & LITTER TOOLS

## BM-08091

## Manual Feed Trimmer Head

BM-08091 SEMI-AUTOMATIC TRIMMER HEAD. The BM-08091 represents a new generation of manual heads. (There's no need to loosen the knob to lengthen the line). Made in Italy. Please specify which arbour you require when ordering. (suits Straight Shaft only).

Refer to application list over the page for correct arbour size.



Part #	Size
BM-102480	8 x 1.25 FEMALE LEFT HAND (COMES IN HEAD)
BM-102481	10 x 1.00 FEMALE LEFT HAND
BM-102482	10 x 1.00 FEMALE LEFT HAND - (STIHL MODELS)
BM-102483	10 x 1.25 FEMALE LEFT HAND
BM-102489	8 x 1.25 MALE LEFT HAND
BM-102490	10 x 1.25 MALE LEFT HAND
BM-102487	12 x 1.75 FEMALE LEFT HAND



### BM-08019

#### TANAKA STYLE ALLOY TRIMMER HEAD.

The BM-08019 head is a universal multi fit head which mounts the same as you would a cutting blade. 2 outlets. 14mm hole. Ref: CH-100



### BM-08027

#### TANAKA STYLE ALLOY TRIMMER HEAD.

The BM-08027 head is a universal multi fit head which mounts the same as you would a cutting blade. Spool type head with 4 outlets. 25mm hole. Ref: CH-300



#### 33" (84cm) & 40"(100cm) long, large jaw style Litter Picker.

33" (84cm) Industrial-quality, durable, lightweight, versatile pick-up tool, made with a sturdy aluminum shaft, and high impact plastic handle. Pick up a coin or a 2 litre bottle. Widest Jaw opening on the market.

**BM-08848** 84cm long  
**BM-08849** 100cm long



#### 32" (80cm) & 40"(100cm) long, rubber suction style Litter Picker.

Lightweight aluminum shaft, high impact plastic handle, rubber cups that can pick up a coin or a brick. Heavy duty, durable and lightweight.



**BM-08462** 80cm long  
**BM-08499** 100cm long  
**BM-08711** Replacement Grip Rubber Cups (sold as a pair)

## QUALITY AT COMPETITIVE PRICES!

ASP supply quality wear resistant parts at extremely competitive prices. All our products come with a 3 month Replacement Parts Warranty (refer to inside of back page for conditions) and are backed by a \$20m Product Liability Insurance.

ASP ships Australia wide with fast & reliable freight companies and pass on our excellent freight rates to you. All items are despatched from our Brisbane warehouse and stocked items leave the same day they are ordered (if order is received prior to 2pm).

Call 07 3881 3464 Fax 07 3881 3474 or email sales@asproducts.com.au

### ARBOUR APPLICATION CHART

BRUSHCUTTER MAKE & MODEL	ARBOUR SIZE		BRUSHCUTTER MAKE & MODEL	ARBOUR SIZE
<b>CRAFTSMAN (MSAA)</b>			<b>HONDA</b>	
KAWASAKI 2400, 2410	8 x 1.25mm LHF		UMK422, UMK425, UMK435	10x 1.25mm LHF
KIORITZ 206F	8 x 1.25mm LHF			
<b>MITSUBISHI 1600, 1605, 1810</b>	8 x 1.25mm LHF		<b>HUSQVARNA</b>	
636-79534C, 218151-2816	10 x 1.25mm LHF		16R, 22R, 24R	8 x 1.25mm LHM
636-795451, 795454, 796231	10 x 1.00mm LHF		24R, 25R (Prior 86)	8 x 1.25mm LHM
636-796232, 796233, 796234	10 x 1.00mm LHF		24R (After S/N 603702)	8 x 1.25mm LHF
636-796242, 636-796243	10 x 1.00mm LHF		225L, 225RI, (1995)	10 x 1.25mm LHF
79534C	10 x 1.25mm LHM		545 FR, FX, FXT, RX, RXT	12 x 1.75mm LHF
9-89658L2, 979551C, 979552C	10 x 1.25mm LHF		<b>JONSERED</b>	
			BR SERIES, BR400, BR450	8 x 1.25mm LHM
<b>ECHO - KIORITZ</b>			LR-200, LR-220B, LR-220L,	8 x 1.25mm LHM
SRM 1400, 140DA, 190,	10 x 1.25mm LHF		LR-260B, LR-300	8 x 1.25mm LHM
200DA, 200BE	10 x 1.25mm LHF		LR-320, LR-400, LR-420,	8 x 1.25mm LHM
SRM 200DB, 200AE, 200CE, 300E	10 x 1.25mm LHF		LR-450, LR-460	8 x 1.25mm LHM
SRM 250E, 2510	10 x 1.25mm LHF		TIGER 40	8 x 1.25mm LHM
SRM 300, 300AE, 300A/E, 303E	10 x 1.25mm LHF			
SRM 302DBX, 400AE,	10 x 1.25mm LHF		<b>KAWASAKI</b>	
400BE, 402DE	10 x 1.25mm LHF		TT30R	10 x 1.25mm LHF
SRM 501DE, 1400, 140DA,	10 x 1.25mm LHF		TD & TG 24	8 x 1.25mm LHF
1500, 1501	10 x 1.25mm LHF			
SRM 2200, 2201, 2205, 2210	10 x 1.25mm LHF		<b>McCULLOCH</b>	
SRM 2300, 2301, 2400, 2410	10 x 1.25mm LHF		MAC22, MAC23	8 x 1.25mm LHM
SRM 2500, 2501, 2501S, 2502, 3000	10 x 1.25mm LHF		MAC57	10 x 1.25mm LHM
SRM 3001, 3010, 3800, 4600	10 x 1.25mm LHF		MAC100A, MAC270,	10 x 1.25mm LHF
STM3000, 3010	10 x 1.25mm LHF		MAC90A, 95A, 95 PRO	10 x 1.25mm LHF
RM 303E	10 x 1.25mm LHF		100A, EB240, PSII	10 x 1.25mm LHF
GT1100, 1100A, GT2101, 2103	10 x 1.25mm LHF		85A, 85S, 85SL, 90, 95, 95A, 99A	10 x 1.25mm LHF

BRUSHCUTTER MAKE & MODEL	ARBOUR SIZE		BRUSHCUTTER MAKE & MODEL	ARBOUR SIZE
<b>McCULLOCH cont</b>			<b>STIHL cont</b>	
EB-IIIVSL	10 x 1.25mm LHF		FS74, FS76 10 x 1.00mm LHF	10 x 1.00mm LHF
EB-280, EB-285BC,	10 x 1.25mm LHF		FS90, FS110, FS130, FS91	10 x 1.00mm LHF
EB-285BCS, FM-3000	10 x 1.25mm LHF		4 mix models,	10 x 1.00mm LHF
PRO-SCRAPER 1, II, IIHD, IV	8 x 1.25mm LHM		FS25-4, FS65-4,	10 x 1.00mm LHF
PRO-SCRAPER EB I, II, III, IV, V	10 x 1.25mm LHF		FS81AVE, FS81AVRE,	10 x 1.00mm LHF
SM100	10 x 1.25mm LHF		FS86AVE, FS86AVRE	10 x 1.00mm LHF
TITAN 2300, 2300A/V	10 x 1.25mm LHF		FR106, FS106, FS106AVE	10 x 1.00mm LHF
TITAN 2400, 2500, 2500A/V	10 x 1.25mm LHF			
TITAN 2250, 2310, 2360,	10 x 1.25mm LHF		<b>TANAKA</b>	
2560av, 2565av	10 x 1.25mm LHF		AST-5000	10 x 1.25mm LHM
TITAN 3000, 3900	10 x 1.25mm LHF		AST-700, AST-7000, AST-7000S	8 x 1.25mm LHM
			BC-350, BC-400	10 x 1.25mm LHM
<b>POULAN</b>			LT-210, LT-210E, NC-301	10 x 1.25mm LHF
900	10 x 1.25mm LHF		SUM-301, SUM-321	8 x 1.25mm LHM
1000	10 x 1.50mm LHF		TB-220, TB-220E	8 x 1.25mm LHM
150, 200	10 x 1.25mm LHF		TBC-160	8 x 1.25mm LHF
2620, 2820	10 x 1.25mm LHF		TBC-16D, TBC-215	8 x 1.25mm LHM
			TBC-202, TBC-205, TBC-210	8 x 1.25mm LHF
<b>RYOBI</b>			TBC-2110, TBC-2510	8 x 1.25mm LHF
GRASS HORNET/WEED HORNET	8 x 1.25mm LHF		TBC-220, TBC-220SS,	8 x 1.25mm LHM
RGH-600	8 x 1.25mm LHF		TBC-232, TBC-233	8 x 1.25mm LHM
RSH-1100MK2	10 x 1.25mm LHM		TBC-240, TBC250,	8 x 1.25mm LHM
SCRUB HORNET RHS900,	8 x 1.25mm LHM		TBC-262, TBC-265	8 x 1.25mm LHM
RSH900HB	8 x 1.25mm LHM		TBC-301, TBC-322,	8 x 1.25mm LHM
			TBC-325 (Older Model)	8 x 1.25mm LHM
<b>SHINDAIWA</b>			TBC-300, TBC-321, TBC-322,	10 x 1.25mm LHM
B40, C35, C350, RC45, BP35,	10 x 1.25mm LHM		TBC-355, TBC-373	10 x 1.25mm LHM
BP45, B450	10 x 1.25mm LHM		TBC-422C, TBC-425,	10 x 1.25mm LHM
BP35, C25, 45, C25, 27, F18, F20,	8 x 1.25mm LHM		TBC-500, TBC-501	10 x 1.25mm LHM
T260, C260, T270, C270, T350	8 x 1.25mm LHM		TBC-425, TBC-4000, TBC-4500	10 x 1.25mm LHM
R20, 25, 35, T25, T250, T260	8 x 1.25mm LHM		TN-3100, TN-3300 (Brain)	10 x 1.25mm LHM
<b>STIHL</b>			<b>TORO</b>	
FS40, FS44, FS55, FS90, FS110,	10 x 1.00mm LHF		1000, 2000, 2100	10 x 1.25mm LHF
FS85, FS120, FS200	10 x 1.00mm LHF		30900, 30910, 30920	10 x 1.25mm LHF
FS50, FS50E, FS51, FS60, FS61,	8 x 1.25mm LHM		51550, 51603, 51604, 51606,	10 x 1.25mm LHF
FS65, FS80 (old), FS90 (old)	8 x 1.25mm LHM		51607, 51608	10 x 1.25mm LHF
FS52AVRE, FS62AVRE, FS66AVE	10 x 1.00mm LHF		CL-700, CL-2100	10 x 1.25mm LHF
FS56AVE, FS56AVRE,	10 x 1.00mm LHF		TC SERIES	10 x 1.25mm LHF
FS66AVE, FS66AVRE	10 x 1.00mm LHF			

## How to return goods

Parts are not sold on a trial basis and can only be returned if fully resalable, and are returned within 14 days from date of purchase. Parts returned after 14 days will incur a restocking fee. When returning goods please ensure your details are clearly marked on packaging or include your proof of purchase with the returned goods.

## Shipping Discrepancies / Damages

(Incorrect parts, shortages, overage & damaged products) must be reported within 24 hours of receipt. Damages must be reported immediately. All external damages should be reported to the carrier and noted on the delivery / shipping document when signing for receipt of goods. Any damages not reported within 24 hours cannot be adjusted / credited.

Please check that the correct number of parcels have been received before signing for receipt of goods.

We stock all of our parts in a 1200m<sup>2</sup> warehouse in Clontarf QLD, and operate a fully computerised system that will ensure your orders are promptly and efficiently despatched. Orders for stocked parts will be available for despatch within 60 minutes of order acceptance by ASP, and transport arrangements from our part of Brisbane to all Australian towns, are excellent.

We normally use Star Track Express or registered Post for deliveries unless otherwise directed, please allow 2-4 days to QLD and NSW , 4-7 days to VIC, NT and SA, and 5-9 days to WA and TAS.

## 3 month Replacement Parts Warranty

All ASP's replacement parts carry a warranty against defects in material and workmanship for 3 months from date of purchase. This warranty is subject to normal wear and tear.

## Product Liability Insurance

ASP's Public/Product Liability Insurance policy is maintained with reputable insurers to provide Public/Product indemnity of \$20 million.

## Disclaimer

Any reference to Original Equipment Manufacturers, ASP competitors, and their part numbers are for reference only. All parts listed are supplied to fit machines indicated and are not sold as genuine.

## IMPORTANT

The information and specifications given in this catalogue is given in good faith as being correct and an accurate guide to ordering and correct part identification. Customers are nevertheless encouraged to thoroughly check for part number correctness before ordering, by verifying sizes, and models fitted, and OEM cross references to ensure any part ordered is correct for your application. ASP reserve the right to upgrade specifications without prior notice.

***© Alloy & Stainless Products Pty Ltd 2003. All rights reserved. No data, information, images etc in this catalogue may be copied, produced, stored on a retrieval system, or transmitted in any form or by any means, without the prior written consent of Alloy & Stainless Products Pty Ltd. "ASP" and "Lightning" are registered Trade Marks of Alloy & Stainless Products Pty Ltd.***



**PH: 07 3881 3464**

**FX: 07 3881 3474**

**WEB: [www.asproducts.com.au](http://www.asproducts.com.au)**

**Email: [sales@asproducts.com.au](mailto:sales@asproducts.com.au)**

PO Box 3175 Clontarf DC Qld 4019,  
359 MacDonnell Rd Clontarf Qld 4019

Ph: 07 3881 3464

Email: [sales@asproducts.com.au](mailto:sales@asproducts.com.au)

[www.asproducts.com.au](http://www.asproducts.com.au)

ABN: 91 088 139 520



**ASP**  
Components TM



In association with our 25 year partnership with La Pina, ASP supply an array of wear resistant products that are manufactured to World Class Standards.

Production of parts incorporates the latest technological advantages in Boron Steel processing. Boron steel is used to provide our customers with superior wear resistant characteristics and excellent value for money! ASP distribute our parts Australia wide and provide fast delivery coupled with great customer service.